

TekDoc

USER MANUAL

2025



/CARGO

MONTY
BIKES

CONTENTS

01 INTRODUCTION	3
SYMBOLS	3
02 MONTY WARRANTY	4
STATUTORY WARRANTY	4
EXTENDED WARRANTY OF UP TO 5 YEARS ON BH MOTORS	4
REGISTERING EXTENDED WARRANTIES.....	5
MONTY SERIAL NUMBER	5
WARRANTY OF PARTS OF THE ELECTRICAL ASSISTANCE SYSTEM.....	5
SUBMITTING A WARRANTY CLAIM	5
CONDITIONS THAT MAY AVOID THE WARRANTY OF ELECTRICAL COMPONENTS	5
03 MAINTENANCE	6
INSPECT THE BICYCLE BEFORE USE	6
KEEP THE BICYCLE CLEAN	6
KEEP THE TRANSMISSION LUBRICATED AT ALL TIMES	6
PART MAINTENANCE.....	6
SPARE PARTS.....	7
AFTER A FALL, BLOW OR IMPACT.....	8
04 WARNINGS ON USE	8
MAXIMUM TYRE SIZE	8
MINIMUM AND MAXIMUM INSERTION LENGTH OF THE SEAT POST	8
MAXIMUM FORK LENGTH (AXLE-TO-CROWN)	8
MAXIMUM NUMBER OF STEERING SPACERS.....	8
POSITION OF THE SPINDLE INSIDE THE FORK TUBE.....	8
INTENDED USE	8
05 WARNINGS ON USE OF THE ELECTRICAL ASSISTANCE SYSTEM	9
CARE AND INSTRUCTIONS FOR USE OF THE ELECTRICAL COMPONENTS AND BATTERIES	9
RECOMMENDATIONS TO MAXIMIZE THE BATTERY LIFE	9
WARNINGS ON THE USE OF BATTERIES.....	9
UNSUITABLE CHARGING AND DISCHARGING ENVIRONMENTS AND SOLUTIONS.....	9
RECYCLING.....	9
MOTOR.....	9
06 PEDAL ASSISTANCE SYSTEM OPERATION	10
COMPONENTS OF THE PEDAL ASSISTANCE SYSTEM.....	10
PEDAL ASSISTANCE SYSTEM	10
PARTS OF THE CONTROL PANEL	10
SWITCHING THE PEDAL ASSISTANCE SYSTEM ON AND OFF	10
TURNING THE BICYCLE LIGHTS ON AND OFF	11
SELECTING THE PEDAL ASSISTANCE MODE.....	11
WALK ASSIST MODE	11
START OF PEDALLING	11
DISPLAYING THE BATTERY CHARGE LEVEL	12
BATTERY AND CHARGER	12

BATTERY CHARGE LEVEL.....	12
ENERGY SAVING MODES	15
DISPLAY OF SECONDARY INFORMATION ON THE SCREEN.....	15
BATTERY CHARGE LEVEL INDICATOR.....	16
SETTINGS MENU	16
NOTIFICATIONS.....	17
ERROR CODES	18

07 SIZES AND DIMENSIONS	19
--------------------------------------	-----------

08 TECHNICAL SPECIFICATIONS	20
--	-----------

09 ASSEMBLY AND SPARE PARTS	22
--	-----------

DIMENSIONS OF THE STEERING TUBE.....	22
MOTOR BH 1E-36V	22
BATTERY	23
DISPLAY	23
SADDLE SEAT POST	24
SPEED SENSOR.....	24
HANGER.....	24
ACCESSORIES.....	25
ACCESSORIES.....	26
CABLING OF THE MECHANICAL PARTS.....	27
CABLING OF THE ELECTRICAL SYSTEM'S PARTS.....	28
WIRING DIAGRAM OF THE ELECTRICAL SYSTEM'S PARTS	29

10 DECLARATION OF CONFORMITY	30
---	-----------

11 HELP AND ADDITIONAL RESOURCES	30
---	-----------

01 INTRODUCTION

This user manual contains important information for proper use and maintenance of the bicycle. In particular, this document contains specific information about the **CARGO (MC425 / MC615 / MC635 / MC625 / MC645 / MC815 / MC825)**. Please read the entire manual carefully. The user manuals of all MONTY models can be consulted on the website at the following address:

<https://www.montybikes.com/manuales/> or <https://www.bhbikes.com/manuales/>

Keep in mind that the manuals on the BH BIKES and MONTY website are updated on a regular basis. Make sure you have downloaded the latest version from the website. You can check the version on the front page.

This document contains additional information to the general user manual, available at:

<https://www.montybikes.com/contacto/> or <https://www.bhbikes.com/manuales/>

You can check the characteristics, recommendations and warranties of third-party parts on their corresponding official websites.

SYMBOLS

This document contains different icons that refer to use, maintenance and assembly warnings. Carefully read the meaning of each one to prevent improper handling or hazardous situations that may result in serious personal injuries or fatal accidents.

SAFETY



DANGER: refers to a hazardous situation that, if not avoided, will lead to serious injuries or even a fatal accident.



WARNING: refers to a hazardous situation that, if not avoided, could lead to serious injuries or even a fatal accident.



ATTENTION: refers to a hazardous situation that, if not avoided, could cause minor or moderate injuries.



RISK OF ELECTRIC SHOCK: refers to a hazardous situation that, if not avoided, could cause serious injuries due to electric shock or even death.



RISK OF SHORT CIRCUIT: refers to a hazardous situation that, if not avoided, could cause short circuits in the electrical components. Short circuits may cause damage to the electrical components and fire.

TOOLS



FLAT WRENCH



ALLEN KEY



TORX KEY



PHILLIPS SCREWDRIVER



10Nm

TIGHTENING TORQUES: on one side of each tool symbol, the tightening torque will be indicated in newton metre.

TYPE OF ASSEMBLY COMPOUND



OIL: light lubrication for elements such as chains and cables.



GREASE: assembly grease.



CARBON PASTE: assembly paste used to increase the friction of the carbon elements.



ADHESIVE: use medium strength thread lock.



Adhesive is used to fasten bolts and make sure that they do not come loose due to vibrations when using the bicycle. Add a drop of thread lock to the tip of the screw thread in all cases. Never apply more than one drop around the thread, since this will make it very hard to remove the bolt.

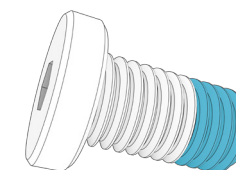

02 MONTY WARRANTY

MONTY BIKES undertakes to offer long-lasting bicycles, in compliance with the highest standards of quality. Therefore, in addition to the statutory warranty, MONTY BIKES offers an additional coverage and warranty. This section defines the different types of warranty and the process that must be followed to register for the additional "LifeTime Frame" warranty.

STATUTORY WARRANTY

The statutory warranty covers the original purchaser in the event of manufacturing defects and/or non-conformities. This warranty applies to frames and components manufactured by MONTY BIKES. The warranty period will be established according to the current laws of the country where the bicycle was purchased, and will start on the date of purchase. During this period, the holder of the warranty will be entitled to have all manufacturing defects repaired or replaced free of charge, including the reimbursement of transport expenses and any losses caused as a result of this. Different conditions must be met in order to be covered by the warranty:

- This warranty does not affect the consumer's applicable rights, according to the current laws in each country.
- Faulty bicycles or parts will be covered by warranty upon the decision of our Technical Service.
- The warranty does not include the replacement of parts prone to wear and arising from normal use of the bicycle.
- The warranty does not cover defects or broken parts due to improper use of the bicycle, use for competitions, mounting of non-original accessories or improper handling and incorrect maintenance work.
- The warranty does not apply if the inspection before delivery and the corresponding inspection intervals included in this document have not been carried out, observed, documented as required and stamped by an authorised BH dealer.
- Should the repair not be satisfactory and not ensure that the optimum conditions are met according to the intended use, the holder of the warranty will be entitled to request the replacement of the purchased item or faulty part with one of identical characteristics, or to receive a refund of the amount paid for the damaged item or part.
- The warranty period will be interrupted during the repairs or, in the event of replaced items or components, it will be renewed.
- Any claim against this warranty shall expire six months after the end of the warranty validity period.
- All warranty claims must be processed by an authorised dealer.
- Geographical scope: refer to the User Manual or www.BHbikes.com

EXTENDED WARRANTY OF UP TO 5 YEARS ON BH MOTORS

Activating the LIFETIME FRAME extended warranty will automatically activate a 5-year extended warranty for all BH motors. Through its authorised stores, Monty provides the original buyer with a commercial policy to cover any manufacturing defects in BH motors for a period beyond that specified in the product's statutory warranty, pursuant to the following clauses:

1. The BH motor extended warranty solely applies to BH motors installed in BH bikes and sold through stores that are authorised by MONTY.

- The buyer must register the warranty online, with the information duly completed, within 30 calendar days of the purchase date, as it appears on the invoice issued by the authorised store, on which the bike's serial no. must be specified.
- This warranty cannot be transferred to subsequent buyers and it is cancelled when the bicycle is sold to a third party. Original buyer means the individual who registers the warranty at the time of the purchase; the commercial warranty cannot be transferred to third parties who are not the original buyer.
- It shall be compulsory to have the bicycle serviced in an establishment that is authorised by Monty and according to the instructions in the user manual.

2. The BH motor extended warranty shall not ever cover:

- Fading paintwork and a loss of original colour, or corrosion caused by normal wear and tear.
- Defects or breakages resulting from an accident or improper and/or negligent use of the bicycle.
- When components or accessories have been installed that are not intended for/compatible with the use for which the bicycle was designed, and when the motor has been tampered with and/or de-limited.
- Defects resulting from improper handling.
- Scratches, discolouration, or stains caused by the use of abrasive fluids, sharp items, clamps and/or prolonged exposure to sunlight or other weather conditions.
- Improper use and/or maintenance of the product (carefully read the recommendations for use and cleaning).
- Motors that have been used in competitions, demos or in rentals.
- Motors mounted on bicycles of the MONTY range.

Read the full terms and conditions at:

https://www.bhbikes.com/es_INT/registro-garantia-vida-bh/registra-tu-bici-garantia-de-por-vida

REGISTERING EXTENDED WARRANTIES

You must register the bicycle within 30 days after purchase to enjoy the BH BIKES additional warranties. The process to activate the extended warranties is described below:

- **LIFETIME FRAME WARRANTY + 5 YEARS WARRANTY ON BH ENGINES**

You must register the bicycle on the BH BIKES website to enjoy the LIFETIME FRAME extended warranty:

https://www.bhbikes.com/es_INT/registro-garantia-vida-bh/registra-tu-bici-garantia-de-por-vida

Watch this video to find out what you need to do:

<https://youtu.be/47aLVgUI248>

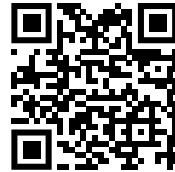

MONTY SERIAL NUMBER

- ⚠ The serial number required to register the bicycle is located on the bottom of the bicycle, on the seat tube, above the bottom bracket:

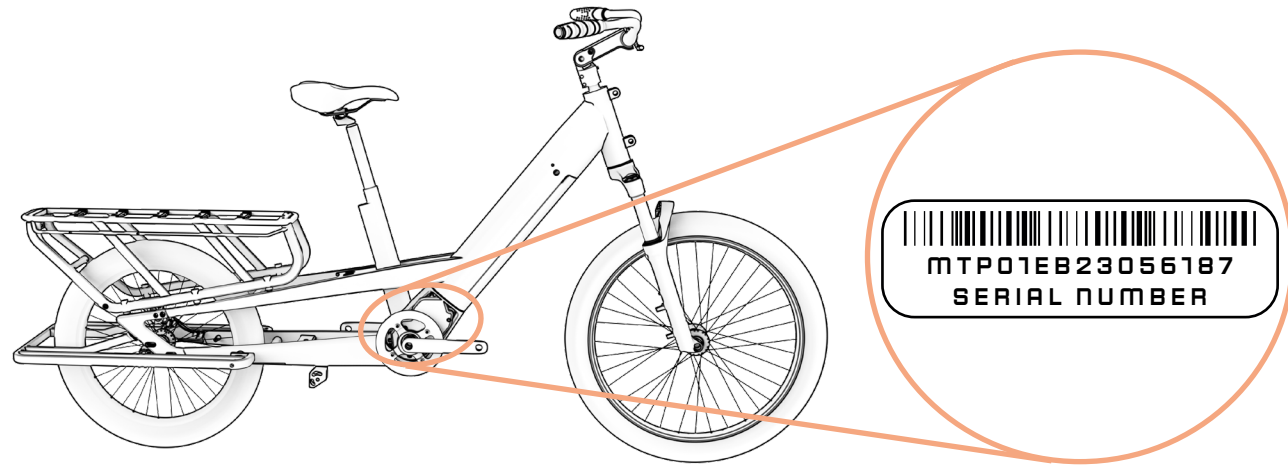

WARRANTY OF PARTS OF THE ELECTRICAL ASSISTANCE SYSTEM

Under no circumstances shall the warranty cover the wear and natural ageing of batteries due to use, charging and storage. Likewise, the buyer must contact the original manufacturer to use the warranty of third-party parts.

SUBMITTING A WARRANTY CLAIM

All warranty claims must be channelled through an official BH dealer. The dealer will analyse the claim to identify its scope and perform a preliminary assessment of the incident. The dealer will submit and process the claim directly with BH. Once BH has defined the corrective measures required, the dealer will send this information to the customer.

All claims must be processed by the official dealer from which you purchased your bicycle. If this is not possible, please contact us directly. We will help you find an authorised dealer near you:

<https://www.montybikes.com/contacto/>

CONDITIONS THAT MAY AVOID THE WARRANTY OF ELECTRICAL COMPONENTS

The Monty battery and electrical components are covered by the statutory warranty, but the following requirements must be met:

- No electrical components must be removed or tampered with.
- The service life will vary according to the use, charging and storage conditions.
- Keep the battery charged at all times. Otherwise, the battery may deteriorate faster than normal.

03 MAINTENANCE

This user manual contains important information for **CARGO (MC425 / MC615 / MC635 / MC625 / MC645 / MC815 / MC825)**. Please read the entire manual carefully. The user manuals of all Monty models can be consulted on the website at the following address:

<https://www.montybikes.com/manuales/> or <https://www.bhbikes.com/manuales/>

This document contains additional information to the general user manual, available at:

<https://www.montybikes.com/manuales/> or <https://www.bhbikes.com/manuales/>

You can check the characteristics and recommendations of third-party parts on their corresponding official websites.

INSPECT THE BICYCLE BEFORE USE

Bicycles are inspected several times throughout the manufacturing process and then at the Monty workshop during the final check. As the bicycle's operation may be affected during transport or third parties may have modified the bicycle before its sale, the following must be checked before each trip:

- **FRAME:** no cracks, damage or strange noises.
- **CHAIN:** it must be lubricated and the transmission system must not make any strange noises.
- **BRAKES:** the brakes must be working properly. When stopped, press the brake lever with enough strength and check that it does not touch the handlebars.
- **TYRES:** the pressure must be correct and there must be no cuts on the tread or on the sides. Also check that the wear level does not exceed the maximum recommended level.
- **WHEELS:** the wheels must rotate freely in order to check how they rotate. Also check the space between the brake lining and the rim, as well as the space between the frame and tyre.
- **STEERING:** the steering must turn smoothly and with no strange noises.
- **SWINGARM ROTATION POINTS:** when weight is exerted on the bicycle, the suspension must work as expected and with no strange noises. If it is not working properly or there is play between the moving parts, this might mean that the tightening torques are incorrect or that the bearings are worn.
- **BEARINGS:** the bearings must work properly and with no strange noises. The bearings are subject to wear and must be replaced to prevent damage to the components on which they are installed.
- **ELECTRICAL SYSTEM:** if the bicycle features an electrical system, check that it is functioning properly by ensuring that the electrical assistance mode is running and that all parts are functioning properly (motor, display, change of assistance mode and speed sensor). If there is no electrical assistance, check that all connections are correct and show no signs of damage.

 Do not ride your bicycle if it does not meet any of these points! A faulty bicycle may cause serious accidents! If you are unsure or have any queries, please contact your nearest Monty workshop!

 Check the tightening torques to make sure that they are as described in the recommendations in the user manuals. Failure to observe these recommendations may result in accidents and even death.

 The effect of the ground and the forces exerted on the wheel subject the bicycle to a lot of stress. The different parts will be subject to fatigue and wear because of these dynamic loads. Check the bicycle at regular intervals to look for signs of wear, scratches, bent parts, wear on the finish or the formation of cracks. Parts may fail suddenly after their service life has expired. Take your bicycle to an authorised Monty workshop regularly to have these parts replaced if needed.

KEEP THE BICYCLE CLEAN

We recommend you follow these basic prevention measures to make sure that the bicycle is in perfect working order. Failure to observe these recommendations may lead to premature wear or even breakages in specific areas, such as gaskets or moving parts.

- Clean the dust and mud with a damp sponge and a gentle and neutral cleaning product.
- Plastic parts must only be washed with soapy water.
- Tyres can be washed with a sponge or brush and soapy water.
- After cleaning the bicycle, dry it by rubbing it firmly with a smooth cloth.
- After each cleaning, lubricate the transmission elements.

 Dirt may cause damage that can result in accidents or even death.

 Never use pressure washers or steam cleaners.

KEEP THE TRANSMISSION LUBRICATED AT ALL TIMES

After washing the bicycle, the chain transmission's lubrication may have also been washed off. Inspect and lubricate the chain's links, if needed. Excess lubrication may attract more dirt, causing premature wear and incorrect functioning of the system.

 Never use pressure washers or steam cleaners.

PART MAINTENANCE

The bicycle requires regular maintenance and a minimum number of regular inspections. The frequency of the maintenance operations depends on the type of vehicle (leisure, road or mountain bike), as well as the frequency and conditions of use.

PART MAINTENANCE CALENDAR

Part	Action required	Before each outing	Monthly	Annually
Lighting	Functional check.			
Tyres	Pressure check.			
	Inspect the height of the profile and sides.			
Brakes (on the rim)	Check the lever travel, lining strength and rim position.			
	Brake test when stopped.			
	Clean the brake pads.			
Brake cables	Visual inspection.			
Brakes (disc brakes)	Change the brake fluid (DOT fluid).			
Suspension fork	Check the bolts and the corresponding tightening torque.			
	Change the oil and lubricate the elastomer.			
Saddle seat post with suspension	Maintenance.			
	Play check.			
Rims on rim brakes	Inspection and replacement, if needed, of the wall linings.	At the latest after the second part of the brake lining.		
Bottom bracket axle	Check the play.			
	Re-lubrication.			
Chain	Check and lubrication.			
	Check and replacement.	After 800 km.		
Chainsets	Check and tightening.			
Wheels / Spokes	Check wheel spin and spoke tension.			
Headset	Inspection of the headset.			
	Re-lubrication.			
Metal surfaces	Maintenance.	At least once every six months.		
Hubs	Bearing inspection.			
	Re-lubrication.			
Pedals	Bearing inspection.			
	Lubrication, cleaning the anchoring mechanism.			

Part	Action required	Before each outing	Monthly	Annually
Saddle seat post / Stem	Inspection of the fastening screws.			
Rear derailleur / Derailleur	Cleaning, lubrication.			
Quick-release mechanism / Thru-axle	Efficacy check.			
Nuts and bolts	Check and tightening.			
Spokes	Tension check.			
Stem / Saddle seat post	Removing and applying new assembly paste.			
Circuit / Brakes	Disassembly and greasing.			
Components of the electrical assistance system	Check the connections.			
	Check there is no dirt.			

 You do not need to take the bicycle to an expert if you are skilled, experienced and have the appropriate tools. Immediately implement the corrective measures if you detect problems. If you are unsure or have queries, please contact Monty.

 The tasks described above must only be carried out by a trusted bike repair expert.

SPARE PARTS

Original parts must be used to ensure the optimum performance of your bicycle and the utmost safety. Failure to use original parts may cause damage that is not covered by the warranty.

The most common spare parts are parts prone to wear. The most common ones are tyres, inner tubes, brake pads, disc brakes and brake pads, as well as rims, when these are part of the brake unit, headlights, position lights, batteries and accumulators.

- **TYRES:** Replace them with an equivalent type of tyre. Check the marking on the outside of the tyre (ETRTO standard). Keep in mind that using a tyre with a larger outer diameter than the recommended one may cause the tip of the foot to touch the front wheel or rear wheel guard when the handlebars turn. The cyclist may lose control of the bicycle and suffer an accident with serious consequences. This can also occur when the pedal chainset is replaced with a longer one.
- **INNER TUBES:** Replace them with a suitable type of inner tube, according to the type of tyre. Refer to the information on the outside of the inner tube (ETRTO standard).
- **DISC BRAKES AND BRAKE PADS:** Follow the instructions supplied by the manufacturer.
- **HEADLIGHTS AND POSITION LIGHTS:** Replace the bulb with one of the same type. Check the indication on the metal area.

- **CHAIN, COG AND CHAIN RINGS:** Follow the instructions supplied by the manufacturer.
- **BATTERIES AND ACCUMULATORS:** Change for the same type. Check the indication on the outer area.

 Remember that the failure to use original parts may cause damage that is not covered by the warranty.

AFTER A FALL, BLOW OR IMPACT

If you suffer a fall, blow or impact, first make sure that you are okay to continue cycling. Do not use the bike if you are injured and ask for medical assistance if needed.

If you are okay to continue cycling, check the bicycle to make sure that it is in perfect working order:

- Check that the wheels are firmly secured and that the rims are in the centre of the frame and fork. Turn the wheels. If they cannot be centred in situ because the gap is too small, separate the brakes from the rim so it can move freely.

 In this case, keep in mind that the braking efficacy will be less.

- Check whether the handlebars or the front of the frame are twisted or broken. Check that the front is firmly seated on the fork, holding the front wheel firmly between your legs and trying to twist the handlebars with respect to the front wheel.
- Check that the chain is fitted correctly. If the bicycle fell onto the transmission side, check that it is working properly. Ask for help to place the bicycle on its saddle and change gears. When the chain fits on the largest cog, check the distance between the gear and the spokes. If the gear or bracket are bent, the first one may become stuck on the spokes - Danger of falling! The gear, rear wheel or frame may be damaged. Check the derailleur. If it has shifted, the chain may come off the gear. The bicycle's transmission will become less effective (also refer to the "Traction" section).
- Check the saddle, upper tube or the bottom bracket box to make sure that there are no defects.
- Lift the bicycle slightly and let it drop onto the ground. If there are any noises, inspect the bicycle for any loose bolts.
- Inspect the entire bicycle again to check for bent areas, worn finish or cracks.
- Ride again carefully if no problems have been detected during the inspection. Do not brake or accelerate suddenly or pedal when going uphill. If you are unsure, wait for a car to pick you up instead of risking an accident. Once home, you should inspect the bicycle carefully again. If you are still unsure or have any queries, please contact your nearest MONTY workshop!

 Bent aluminium parts must not be straightened, i.e., they must not be repaired. Even afterwards, there is a high risk of breakage, especially in regards to the fork, handlebars, front part, chainsets and pedals. Replace them for greater safety.

04 WARNINGS ON USE

MAXIMUM TYRE SIZE

If you install a tyre of a different size on your bicycle, check and make sure that there are at least 6 mm between the tyre and other parts of the frame and fork.

MINIMUM AND MAXIMUM INSERTION LENGTH OF THE SEAT POST

Failure to observe the maximum and minimum seat post insertion dimensions indicated in this manual may cause a lever effect on the frame. The pressure exerted could damage the frame and cause serious accidents. The warranty does not cover the damage generated by failing to observe these indications.

MAXIMUM FORK LENGTH (AXLE-TO-CROWN)

Observe the maximum length between the fork axle and the lower part of the steering tube (axle-to-crown). If this maximum length is not observed, the frame could be damaged due to withstanding a greater load than that for which it was designed and may cause serious accidents.

MAXIMUM NUMBER OF STEERING SPACERS

This manual specifies the maximum number of steering spacers that can be fitted under the stem. If this maximum quantity is not observed, the materials could be damaged due to withstanding a greater load than that for which they were designed and may cause serious accidents.

POSITION OF THE SPINDLE INSIDE THE FORK TUBE

No steering spacers must be fitted above the stem. Otherwise, the materials could be damaged due to withstanding a greater load than that for which they were designed and may cause serious accidents.

INTENDED USE

Each bicycle has been designed according to a specific intended use. The models described in this manual meet the requirements associated with their intended use:

This is a set of conditions for the operation of the bicycle that provides for its use on city roads. In addition, the wheels must be kept in contact with the running surface at all times

05 WARNINGS ON USE OF THE ELECTRICAL ASSISTANCE SYSTEM

CARE AND INSTRUCTIONS FOR USE OF THE ELECTRICAL COMPONENTS AND BATTERIES

All Monty products and parts have been designed to withstand splashed liquids and rain. However, some practices may cause damage to the parts and short circuits. Do not do the following:

- Wash the bicycle with pressure devices.
- Use the bicycle under adverse weather conditions.
- Transport the bicycle on the outside of a vehicle when it is raining.
- Expose the batteries to very high temperatures. If the temperature exceeds 70°C, this could cause leaks and there could be a risk of fire.
- Fail to observe the working temperature, storage and charging range of the bicycle.

RECOMMENDATIONS TO MAXIMIZE THE BATTERY LIFE

We recommend the following to maximise the battery life:

- Charge it on a flat and stable surface.
- Make sure that it is not exposed to direct sunlight.
- Make sure that there are no children or pets near.
- Make sure that there is no rain or dampness.
- The place must be well ventilated and dry.
- The temperature must be between 15-25°C.
- Do not use the battery with a charge of less than 10%. The useful life of the cells may be affected below this charge level.

 Any unauthorised handling of the electrical system's components may cause serious accidents and will void the warranty.

WARNINGS ON THE USE OF BATTERIES

Improper use of the batteries may cause damage and serious accidents. Follow these recommendations to prevent this:

- Always use the original battery charger.
- Never leave the battery near sources of heat.
- Do not heat the battery or throw it into a fire.

- Prevent the battery connections from coming into contact with metal objects.
- Do not submerge the battery in water and prevent splashes and dampness.
- Do not hit or drill holes into the battery.
- Make sure that the battery liquid does not touch your hands or eyes in the event of a leak.
- Do not use it if there are external signs of damage.
- Only clean the battery with a dry or damp cloth.

UNSUITABLE CHARGING AND DISCHARGING ENVIRONMENTS AND SOLUTIONS

The hot and cold environments described below may lead to charging entering standby or sleep mode without fully charging the battery.

- **Winter discharging sleep mode or DUT (Discharge Under Temperature):** Battery discharging will enter the deep sleep mode if the temperature is below -20°C, stopping the pedal assistance system from working and protecting the battery. In such cases, sleep mode will automatically be disabled when the battery exceeds -20°C.
- **Winter charging sleep mode or CUT (Charge Under Temperature):** Battery charging will enter sleep mode if the temperature is below 0°C. If charging starts and the temperature falls below this level due to night cooling or other factors, charging will stop and sleep mode will be activated to protect the battery. In such cases, sleep mode will automatically be disabled when the battery exceeds 0°C.
- **Noise on televisions/radios/computers:** Charging near televisions, radios or similar devices may cause static electricity, flickering images and other interference. If this happens, recharge somewhere that is away from the television or radio (e.g. in another room).

RECYCLING

Ion-lithium batteries can be recycled but they may harm the environment if they are not managed properly after the end of their service life. Follow these steps after the end of their service life:

- Classify and recycle each electrical component in a place prepared for the sustainable recycling of such parts.
- Check and make sure that the applicable regulations of your country are observed with regards to batteries.

MOTOR

The DC motor is located on the bottom bracket axle. The motor's service life depends on its use, as in the case of any other part of the bicycle. Under normal conditions, the motor can last for 10 to 20 years, or up to 100,000 km.

06 PEDAL ASSISTANCE SYSTEM OPERATION

COMPONENTS OF THE PEDAL ASSISTANCE SYSTEM

The Monty Bikes pedal assistance system is made up of the following components:

- **A. A motor**, which drives the bicycle.
- **B. A control panel** which, among other things, allows you to select the assistance mode.
- **C. A battery**, which powers the motor.
- **D. A torque sensor**, which reads the force applied to the pedal by the user.
- **E. A display** (X DISPLAY), which shows relevant system information.

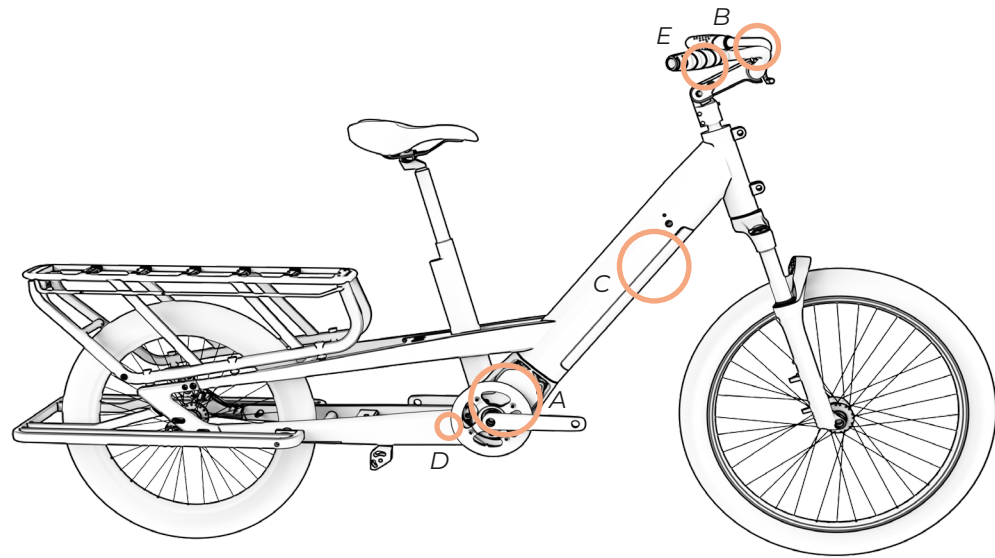

PEDAL ASSISTANCE SYSTEM

The pedal assistance system is designed to provide the optimal amount of assisted power. It provides assistance within a standard range, based on factors such as the pedalling force, the speed of the bicycle and the transmission.

The system does not provide assistance in the following situations:

- If the control panel is off.
- When travelling at 25 km/h or faster.
- If you are not pedalling and the throttle function is released at 6 km/h.
- If there is no remaining battery capacity.
- If the assistance mode selected is 0% assistance.

PARTS OF THE CONTROL PANEL

The X-Remote (general control panel) is located on the left side of the handlebars, next to the grip. The control consists of 3 parts:

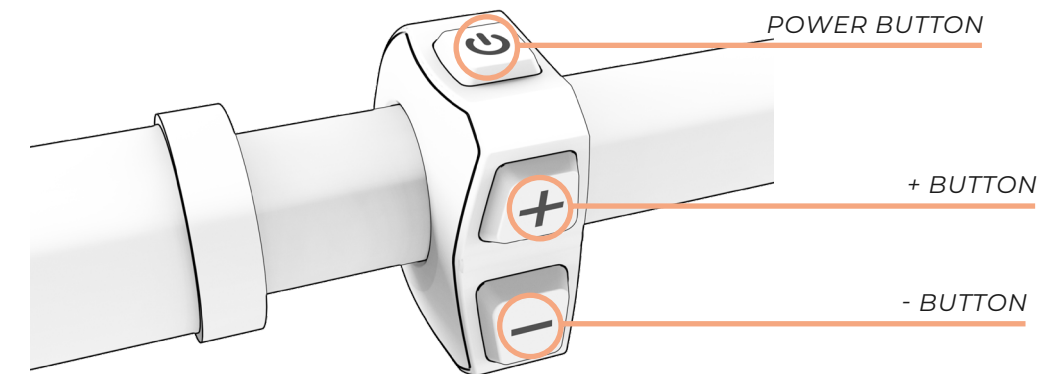

SWITCHING THE PEDAL ASSISTANCE SYSTEM ON AND OFF

The pedal assistance system is switched on from the X-Remote (central control panel). It is located next to the left grip on the handlebars. Press the power button to start the system. The X-Display will turn on showing the current pedal assistance mode. If the battery has been removed from the frame and put back into its position, the system will also turn on, starting the display (see the section "Releasing and removing the battery").

To turn off the pedal assistance system, press and hold the power button for 3 seconds. The screen will turn off and the system will shut down.

- ⚠ After turning the system on, make sure that you do not start riding without checking the assistance mode. By default, it starts with the assistance mode selected before it was last switched off.
- ⚠ Wait for 3 seconds after turning on the system before you start applying pressure on the pedals. During this 3-second period, the assistance system is starting up and calibrating the torque sensor. Otherwise, if you press the pedals beforehand, this may reduce the effectiveness of the assistance system and error 14 may even be displayed on the screen (see the "Error code" section). To fix this, you should reboot the system without applying pressure to the pedals for the 3-second period.

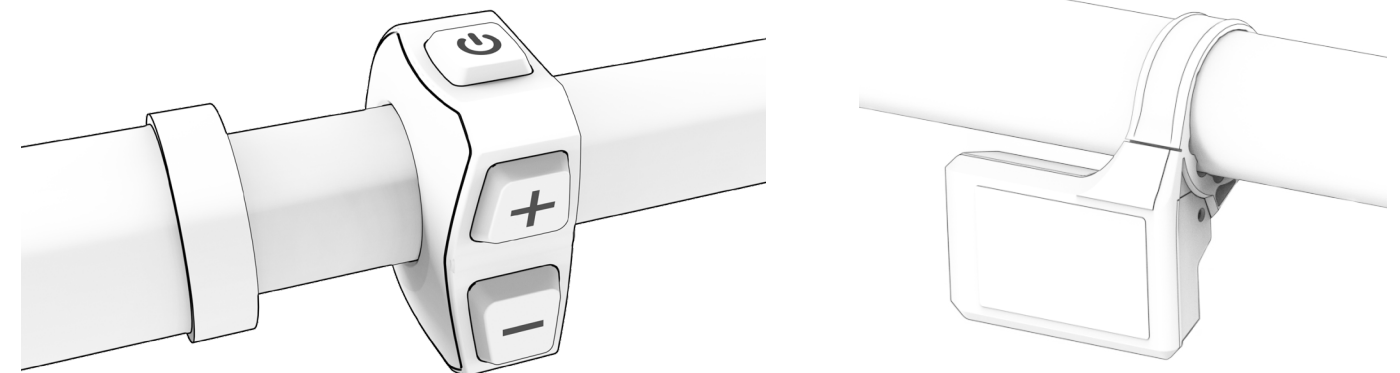

TURNING THE BICYCLE LIGHTS ON AND OFF

When you press and hold the (-) button for 3 seconds, lights are switched on and off in those models equipped with a battery-powered light system.

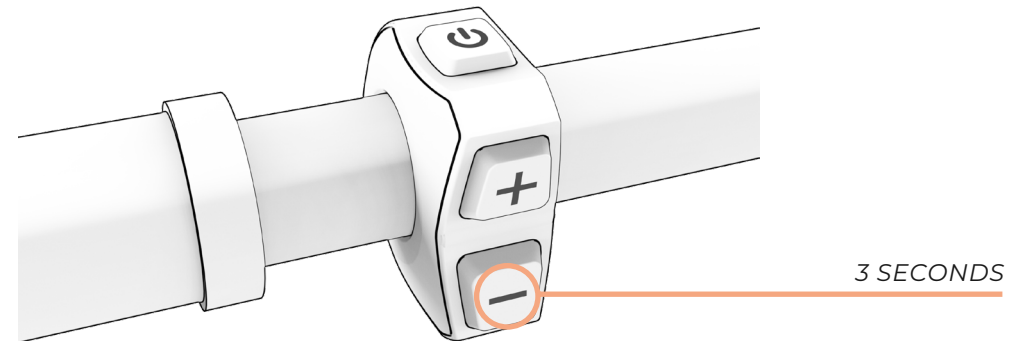

SELECTING THE PEDAL ASSISTANCE MODE

The system features the following pedalling assistance modes:

- **Boost:** Identified by the colour **Red**. Use when you want to get peak power from the system.
- **Sport:** Identified by the colour **Orange**. Use when climbing difficult terrains.
- **Eco+:** Identified by the colour **Blue**. Use when you want a more comfortable ride, e.g. when climbing a steep hill.
- **Eco:** Identified by the colour **Green**. Use when you want to travel as far as possible.
- **No assist:** Identified by the colour **White**. Use when you want to travel without assisted power. You can continue to use the other functions of the control panel.

To toggle through the assistance modes, the user must press the (+) button to increase the level of assistance and the (-) button to reduce the level of assistance.

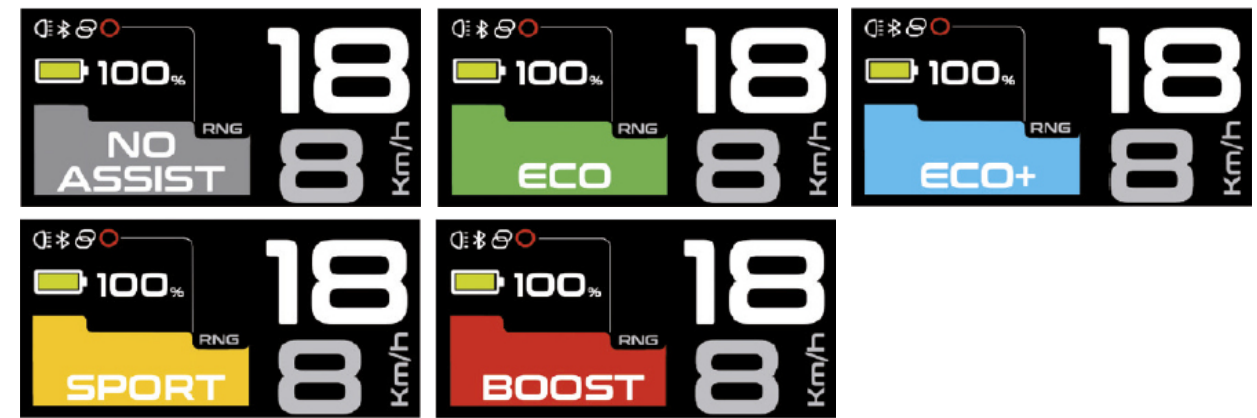
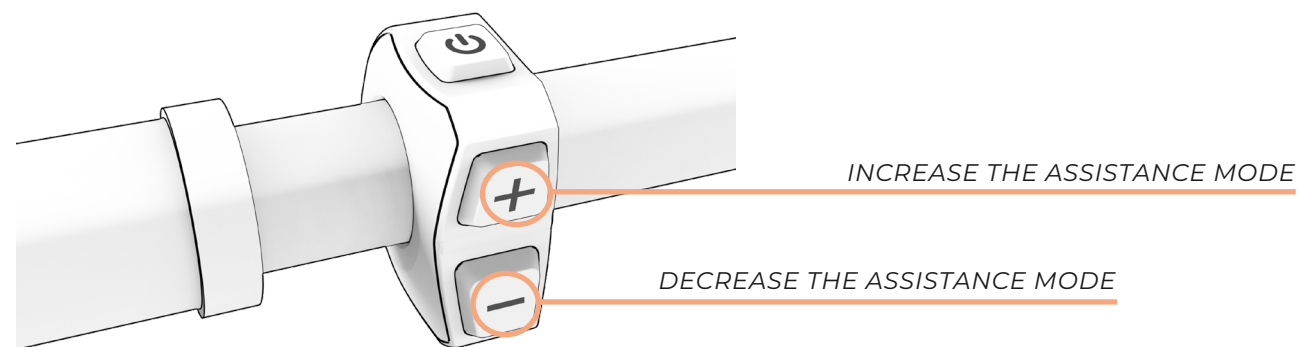

In order to increase the life of the battery and prevent a full discharge which may damage it, the assistance modes are limited based on the state of charge of the battery:

- Battery charge above 20%: 100% of the highest assistance level is available.
- Battery charge between 10% and 20%: assistance level limited to 50% of the highest assistance level.
- Battery charge between 5% and 10%: assistance level limited to 25% of the highest assistance level.
- Battery charge between 1% and 5%: assistance is not permitted. Only the lights can be turned on.

WALK ASSIST MODE

The walk assist mode helps the user to transport the bike by foot. To activate this mode, press and hold the + button on the control panel (it doesn't matter which assistance mode is selected when the + button is pressed). The LEDs on the X-Remote control panel will flash blue, indicating that this mode has been activated. Release the + button to exit this mode.

START OF PEDALLING

Before resting your feet on the pedals, you must sit on the saddle and hold the handlebars firmly. Special care should be taken if you start pedalling when using a high assistance mode (TRACK and BOOST modes), as the motor will respond with maximum thrust and you may lose control. To facilitate acceleration, the motor provides an additional initial thrust as soon as you start pedalling. Therefore, minimal force is required to put the bicycle in motion, helping you to join the traffic quickly and safely.

- ⚠ Start pedalling with a short gear ratio (higher gears) and low assistance mode (ECO mode). As well as providing greater control and safety on the bicycle, it requires less energy consumption and, therefore, ensures a longer range. Starting to pedal with a higher assistance mode (TRACK and BOOST modes) may put the user at risk.
- ⚠ When the user pushes the bike while walking alongside it, they must make sure that the system is disconnected.

DISPLAYING THE BATTERY CHARGE LEVEL

A 100% charge can provide a range of up to 130 km. The battery charge level can be displayed in two ways: from the display or from the removable battery. The battery charge level indicator shows the estimated remaining battery capacity in all cases:

- **X-Display:** the top left of the display shows the battery icon with the battery charge level percentage:



- ⚠ The range of the system will vary depending on the following riding conditions, among others: frequent starts and stops, transmission ratio, numerous steep slopes, road surface in poor condition, carrying heavy loads, strong wind coming towards the cyclist, low temperatures, degradation of the battery, use of the built-in lighting system, incorrect tyre pressure, chain or brake settings.

- **Battery:** the battery features 5 LEDs, as shown in the image. These indicate the battery charge level, according to whether the LEDs are on or off. Press the power button on the battery to turn on the LEDs:

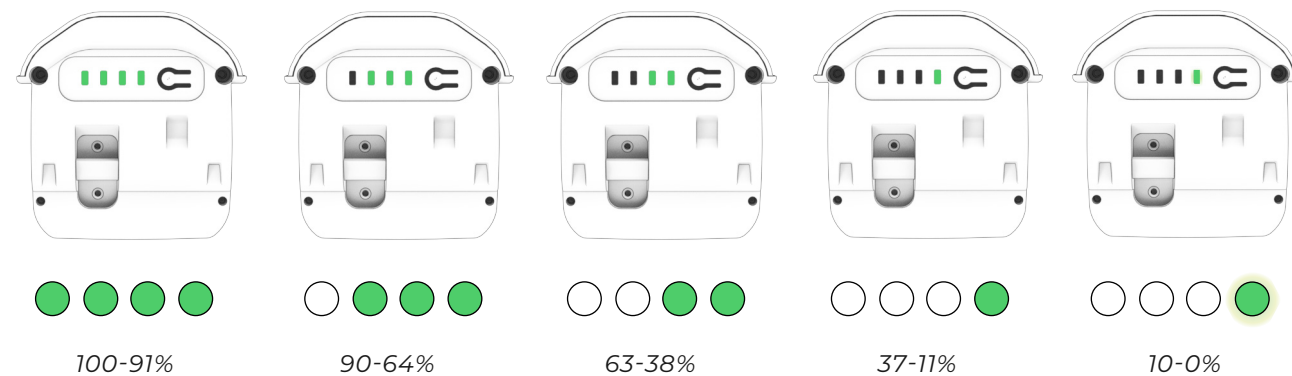

ALARM INDICATION

LED Code	Description	Action required
○ ● ○ ●	Temperature protection	Remove the charger from the battery. Leave the battery in a room temperature away from direct sunlight until the internal temperature of the battery is normal.
● ○ ○ ●	Charging error	If the battery is plugged into the charger, please unplug the charger.
○ ○ ● ○	Discharging error	
○ ● ○ ○	Low voltage error	Connect the charger to the battery for over 30 minutes.
● ○ ○ ○	Battery malfunction	Contact the dealer.
● ● ○ ●	System error	If the error status remains, please contact the dealer.

BATTERY AND CHARGER

The battery that your MONTY bicycle is equipped with lithium-ion cells and is the most advanced technology available in terms of energy density (energy stored per kilogram of weight and per cm³ of volume).

Lithium-ion batteries have the following characteristics:

- Their performance decreases in extremely hot or cold environments.
- An additional characteristic of MONTY's lithium-ion batteries is that they have no "memory effect", and are not affected by incomplete discharging.
- They lose their charge naturally and gradually with use. The battery can be fully discharged (100%) approximately 500 times, with maximum battery deterioration of 20%. In the case of partial discharges, only the discharged part is counted. For example, if you charge the battery every time its charge level falls by 25%, you will be able to charge it to 100% of its initial capacity 2,000 times. In short, the guaranteed durability of the battery with maximum degradation of 20% is at least 20,000 km.

BATTERY CHARGE LEVEL

Due to its advanced lithium-ion technology, there is no need to wait for the battery to completely discharge before connecting it to the charger. Likewise, it is also not necessary to charge it to 100% before using it again. But bear in mind that, in order to achieve a maximum operating range, a full charge is recommended.

The battery can be charged while mounted on the bicycle and when it is removed from the frame. The steps that must be followed to charge the battery correctly in both cases are described below:

CHARGING THE BATTERY INSIDE THE FRAME.

1. TURN ON THE DISPLAY. IT WILL NOT CHARGE IF THE DISPLAY IS OFF.

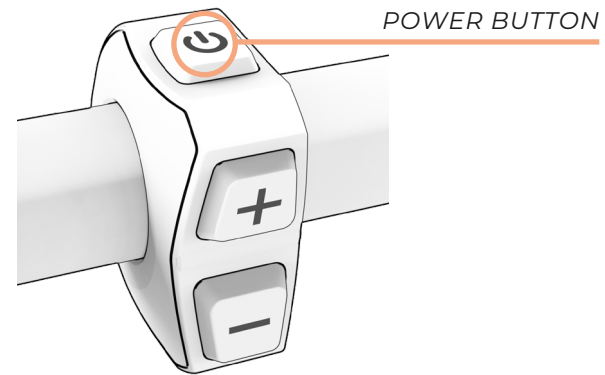

2. OPEN THE COVER OF THE CHARGING PORT ON THE LOWER LEFT SIDE OF THE FRAME.

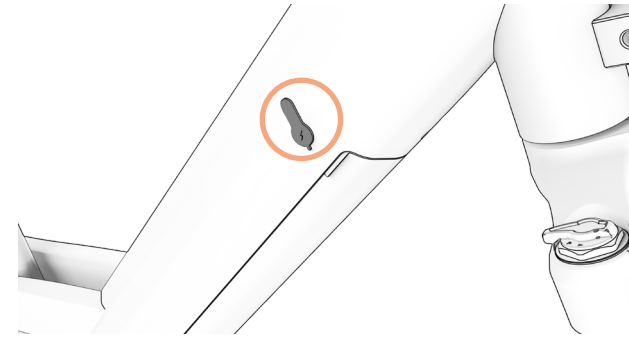

5. ALWAYS DISCONNECT THE BATTERY CHARGER FIRST AND THEN REMOVE THE PLUG FROM THE POWER SOCKET.

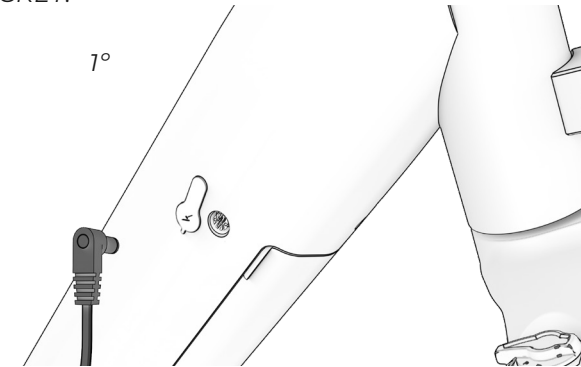

6. CAREFULLY CLOSE THE CHARGING PORT COVER, MAKING SURE NO DIRT OR WATER ENTERS.

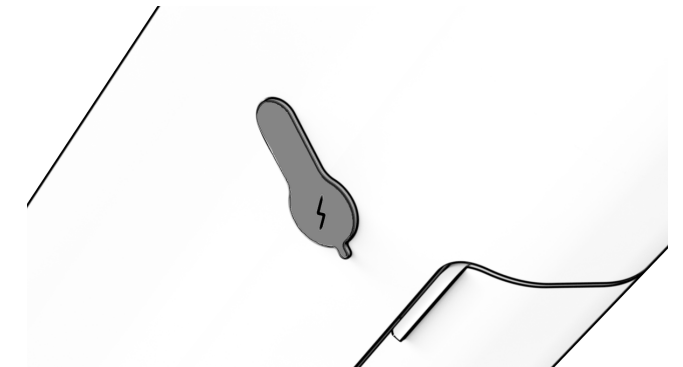

3. CONNECT THE BATTERY FIRST AND THEN PLUG INTO THE POWER SOCKET.

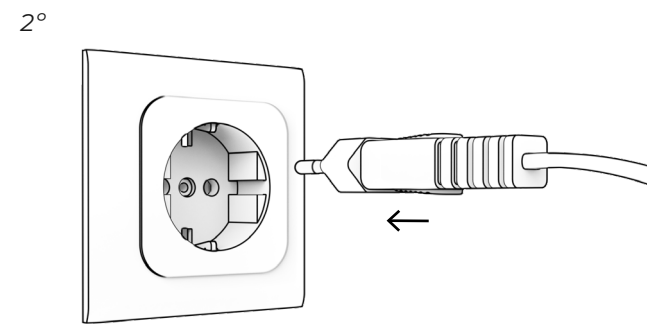
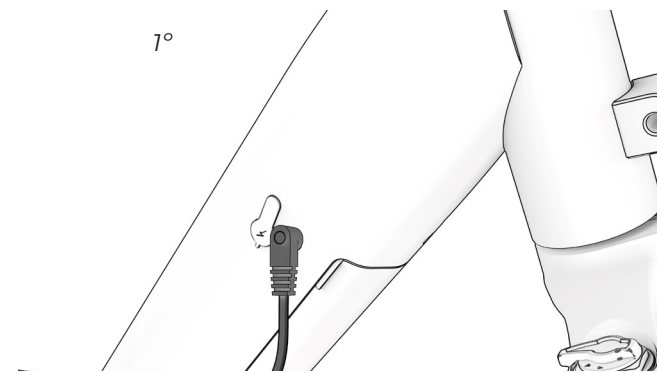

CHARGING THE BATTERY OUTSIDE THE FRAME.

1. TURN OFF THE DISPLAY.

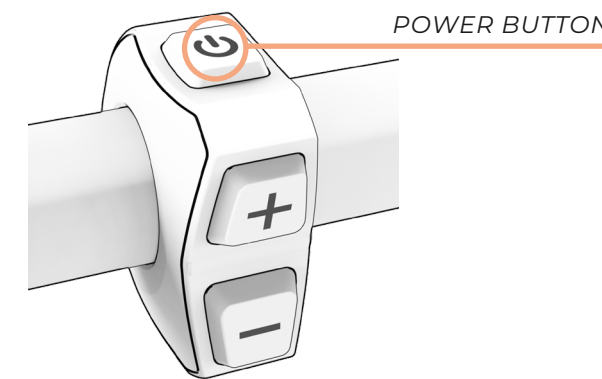

2. OPEN THE LOCK ON THE TOP LEFT OF THE FRAME TO RELEASE THE BATTERY.

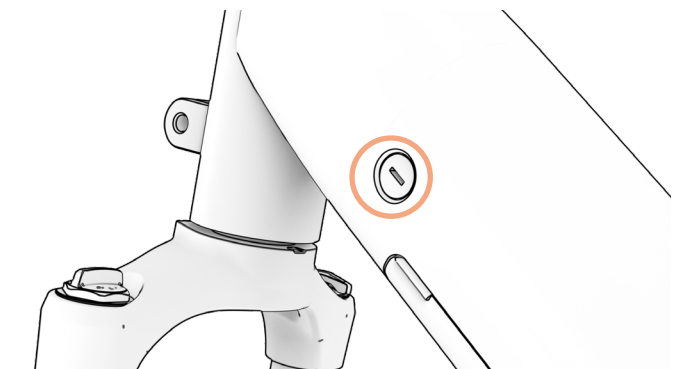

4. VIEW THE STATE OF CHARGE AND ERRORS.

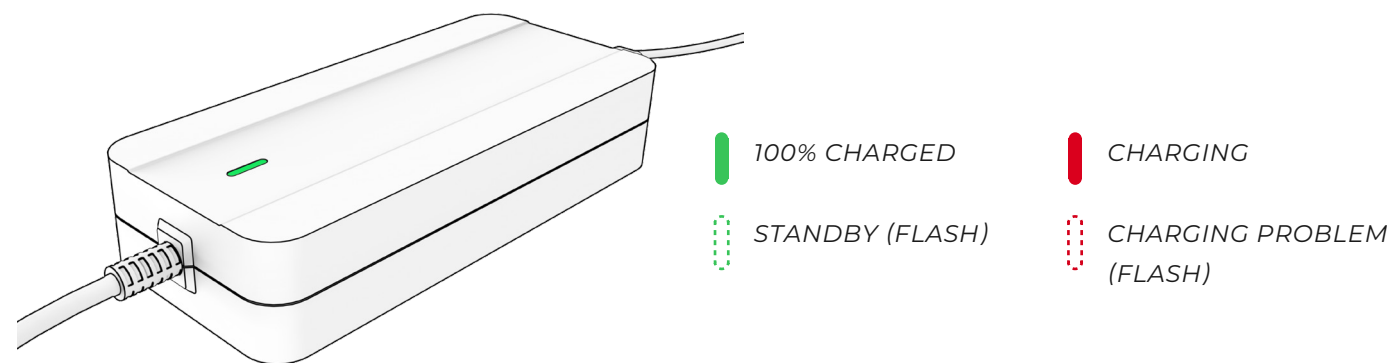

3. LOWER THE BATTERY FROM THE TOP, SO IT PIVOTS ON THE BOTTOM PART, BEFORE REMOVING IT COMPLETELY.

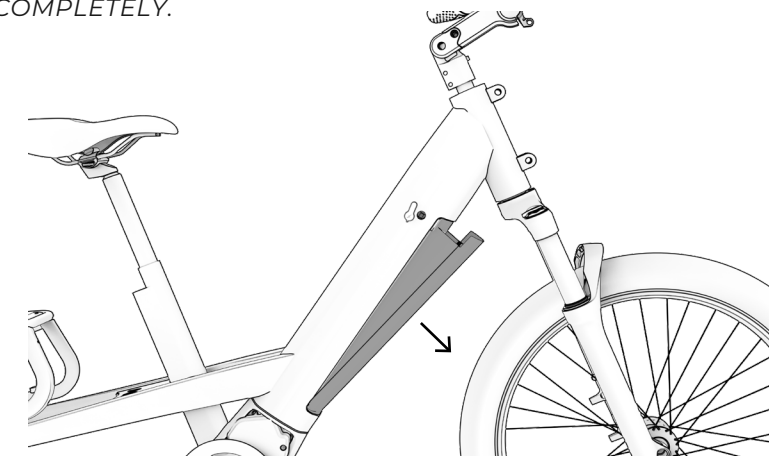

4. CONNECT THE ADAPTOR TO THE CHARGER, SO IT CAN BE CONNECTED TO THE BATTERY.

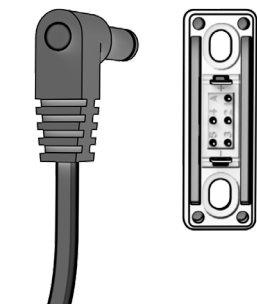



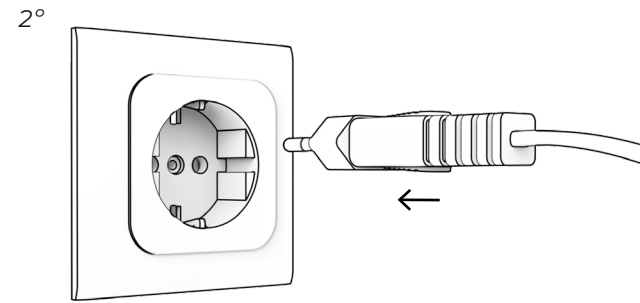
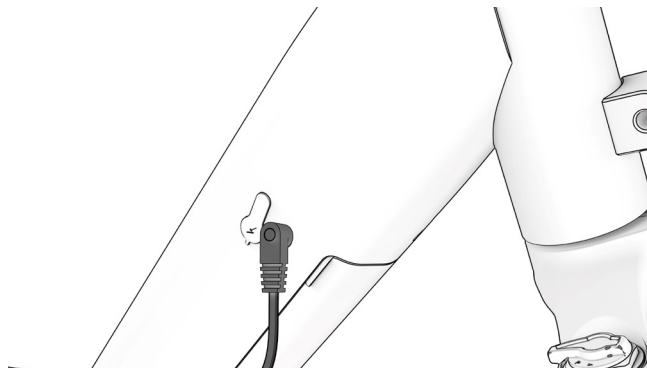

5. CONNECT THE BATTERY FIRST AND THEN PLUG INTO THE POWER SOCKET.



6. VIEW THE STATE OF CHARGE AND ERRORS.







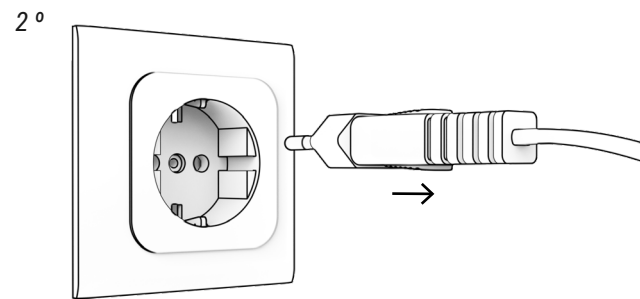
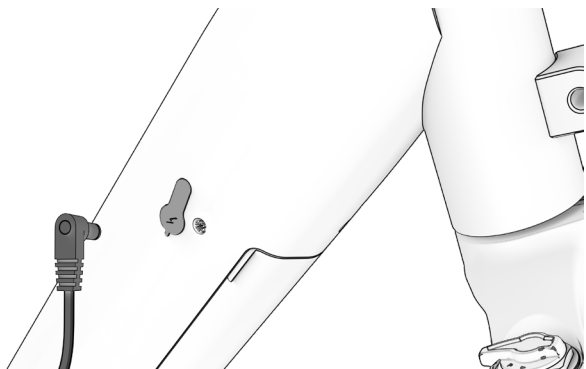



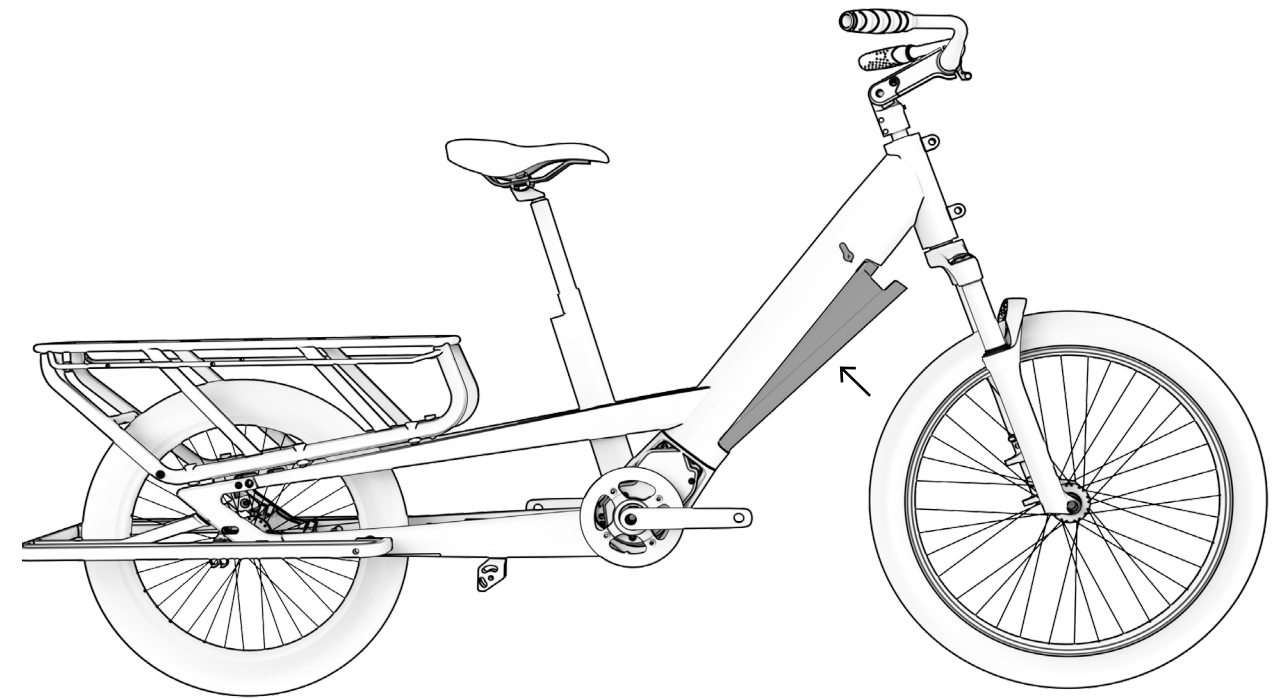

- | | | | |
|---|-----------------|---|--------------------------|
|  | 100% CHARGED |  | CHARGING |
|  | STANDBY (FLASH) |  | CHARGING PROBLEM (FLASH) |

7. ALWAYS DISCONNECT THE BATTERY CHARGER FIRST AND THEN REMOVE THE PLUG FROM THE POWER SOCKET.



8. FIT THE BATTERY INTO THE FRAME, BY FITTING IT INTO THE TOP OF THE FRAME FIRST. PIVOT IT FROM THIS POINT UNTIL IT IS FITTED INTO THE BOTTOM PART.



-  Never charge or use a damaged battery.
-  Be careful not to touch the charger during the charging process. It may be hot, especially in high ambient temperatures.
-  If a fault occurs while the battery is being charged, remove the charger's power plug from the socket and wait for the battery to cool down.
-  Never touch the power plug, charging plug or contacts with wet hands.
-  Make sure that there is no foreign matter on the battery's contacts before placing it on the bicycle.
-  Do not connect the charger's power plug to the battery or bicycle's charging port if it is wet or damp. Make sure that you only connect the power plug when the battery or bicycle's charging port is completely dry.
-  Do not apply excessive force on the power plug or pull the cable with the power plug connected to the battery.
-  Turn off the pedal assistance system before removing the battery from the bicycle.
-  Use both hands to remove the battery, taking special care not to drop it. Dropping the battery on your foot could cause injury and may damage the battery.

ENERGY SAVING MODES

The battery has been designed to ensure a long service life. This is possible thanks to the energy saving modes that prevent inefficient battery consumption:

- **Transport mode:** In order to minimise internal consumption while transporting the bicycle from the factory to the store, the battery is in Transport mode. The user can finally exit this Transport mode by charging the battery to 100% before its first use.

If the battery does not charge fully, the Transport mode will not deactivate, repeatedly entering this mode quickly for its protection. Remember to fully charge the battery to finally deactivate the Transport mode.

- **Standby mode:** In order to minimise internal consumption, the battery automatically switches to Standby mode. This happens automatically when the system detects no charging, no discharging and no communication with the battery for a period of 10 minutes. So, for example, this mode will automatically turn off the control panel after 10 minutes without use, if the user has left it on after parking.

The user can exit this Standby mode by simply turning on the bicycle's control panel.

- **Deep Sleep mode:** In order to protect the battery during long periods of inactivity or storage (for example, during the winter), the battery automatically switches to Deep Sleep mode. This happens automatically when any of the following situations occur:

- If the charge level of the battery is below 1%, the battery goes into Deep Sleep mode when the battery has continuously been in Standby mode for 10 minutes.
- If the charge level of the battery is below 10%, the battery goes into Deep Sleep mode when the battery has continuously been in Standby mode for 48 hours.
- If the charge level of the battery is below 40%: Deep Sleep mode is activated when the battery has continuously been in Standby mode for 14 days.
- If the charge level of the battery is below 80%: Deep Sleep mode is activated when the battery has continuously been in Standby mode for 30 days.

The user can exit this Deep Sleep mode by pressing and holding the battery's SOC button (which checks the charge level) for 5 seconds or by starting to charge the battery with the charger. All LEDs will flash twice in the Standby mode and once in the Deep Sleep mode.

DISPLAY OF SECONDARY INFORMATION ON THE SCREEN

The control panel's screen allows the user to view a range of useful information. The information on the screen changes when you press the POWER button according to the previous selection made in the "Settings" menu:

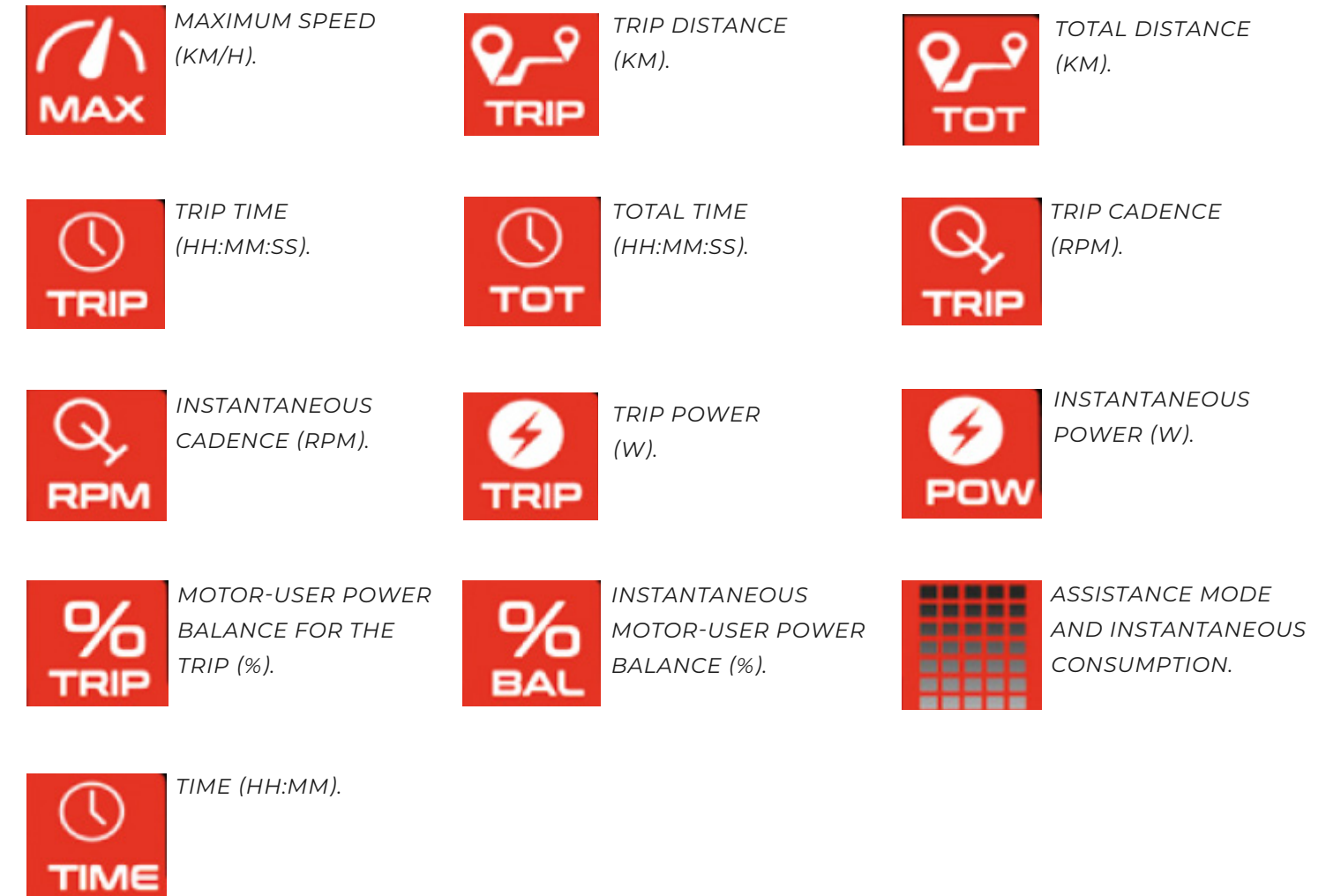

BATTERY CHARGE LEVEL INDICATOR

The battery charge level indicator shows the estimated remaining battery capacity.

In order to increase the life of the battery and prevent a full discharge which may damage it, the assistance modes are limited based on the state of charge of the battery:

- Battery charge above 20%: 100% of the highest assistance level is available.
- Battery charge between 10% and 20%: assistance level limited to 50% of the highest assistance level.
- Battery charge between 5% and 10%: assistance level limited to 25% of the highest assistance level.
- Battery charge between 1% and 5%: assistance is not permitted. Only the lights can be turned on.

SETTINGS MENU

The user can access the settings menu by pressing and holding the (+) and (-) buttons for 3 seconds. Press the (+) and (-) buttons to scroll through the different settings options. When you press the POWER button, you will enter the selected menu. Additionally, the system will exit the settings menu when the user presses and holds the POWER button for 3 seconds.

- ⚠ When making any adjustments, make sure that you stop the bicycle and perform them in a safe place. Otherwise, the lack of attention to the surrounding traffic could cause a fatal accident.

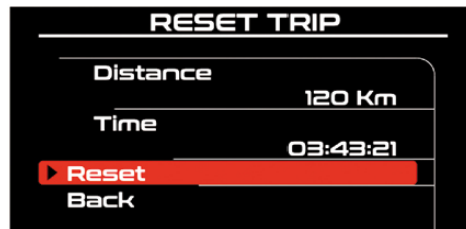

Resetting the trip information.

The user can view and reset the trip information at any time.

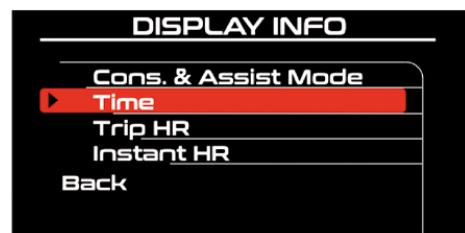
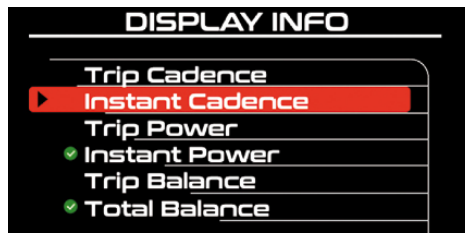
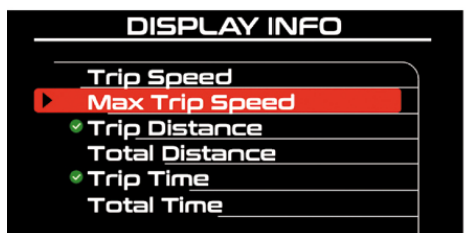

Selecting Secondary information on the Screen.

The user can select the information that will be shown on the screen's secondary information indicator.

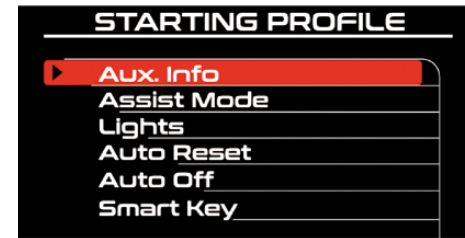

Start-up profile.

The user can select the system start-up settings. Every time that the user turns the control panel on and off, the system will change the settings to those selected in this menu:

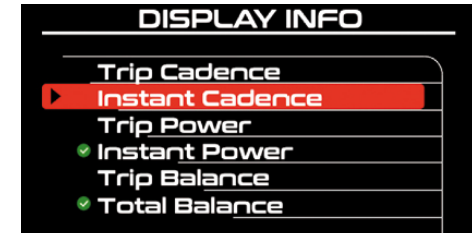
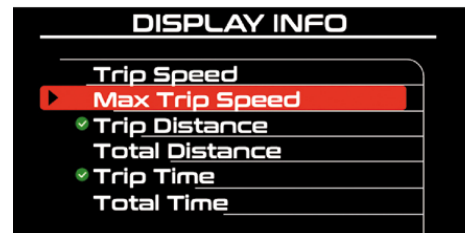

Secondary information.

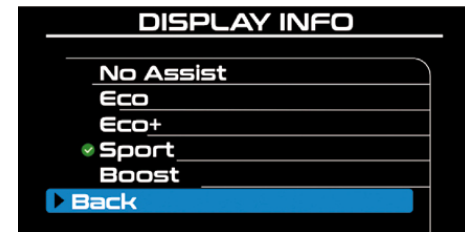

Secondary information.

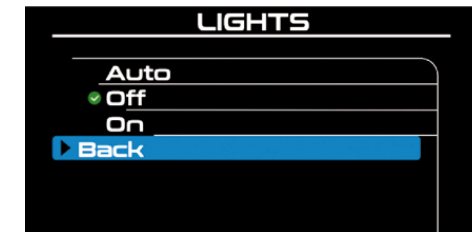

Lighting system.

This operates according to the control panel's lighting level sensor.

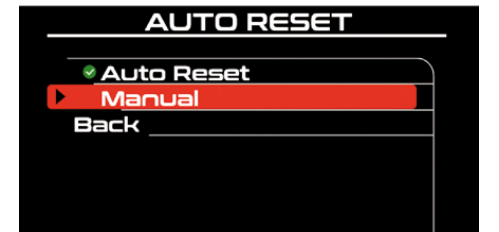

Resetting trip information.

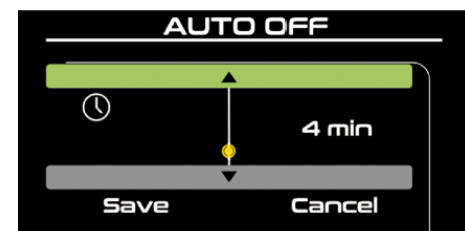

Auto power-off.

Sets the display's auto power-off time.

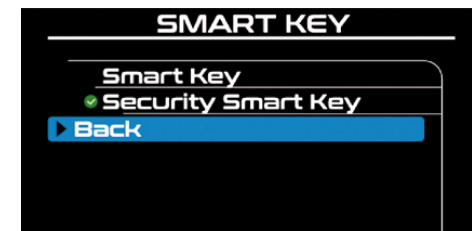

Smart key / Security Smart key.

Activates or deactivates the security function.

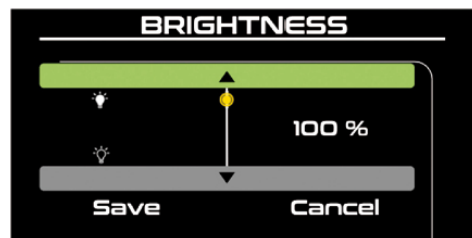

Screen brightness selection.

The user can alter the brightness of the screen so that they can view it correctly.

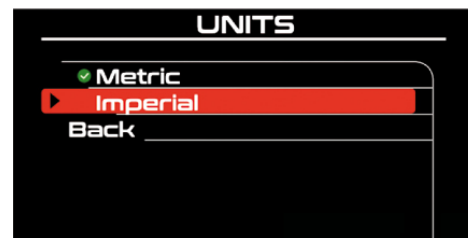

Metric and Imperial systems.

The user can switch between the metric system (kilometres) and imperial system (miles).

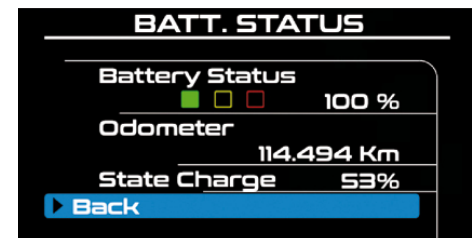

Condition of the battery.

Via this menu, the user can view the battery's state of deterioration.

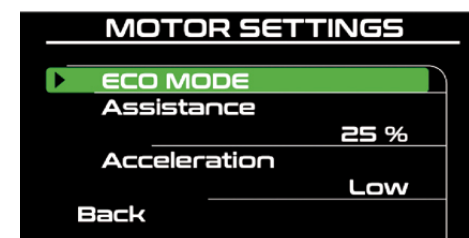

Motor settings.

Via this menu, the user can manage the motor's performance for each assistance mode.

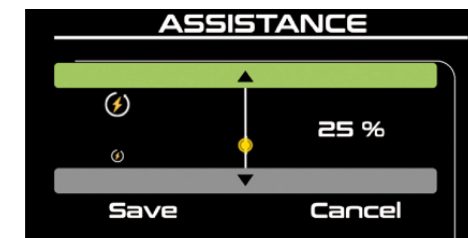

Assistance level by mode.

This is the minimum (1%) and maximum (100%) percentage level of assistance offered by the motor.

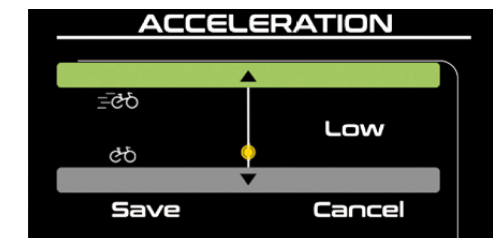

Acceleration.

There are 3 levels (Low, Medium, High) that represent the level of acceleration when starting up the motor.

The battery is a consumable that degrades over time and with use, gradually losing its energy storage capacity. The state of deterioration of the battery (State of Health) offers information about the speed of the battery deterioration based on the following colour criteria:

- **Green:** Low deterioration level.
- **Orange:** Moderate deterioration level.
- **Red:** High deterioration level.

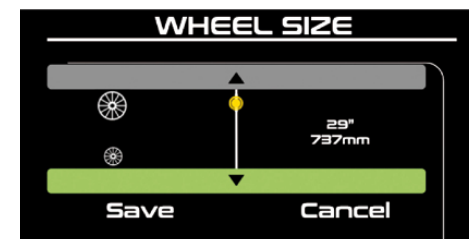

Wheel Size Selection.

The user can change the wheel size at any time.



Language selection.

The user can change the screen language.

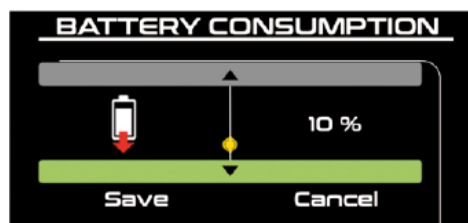
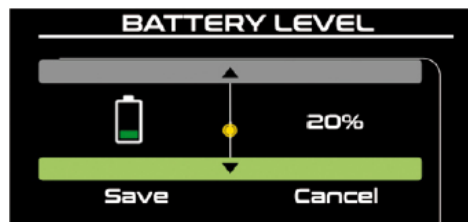
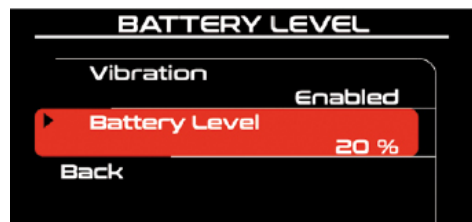

NOTIFICATIONS

The notifications can also be managed in the setup menu. This model has the following notifications:

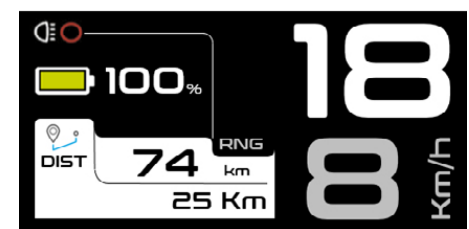

Distance.

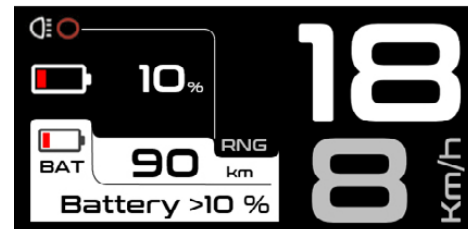

Battery level.

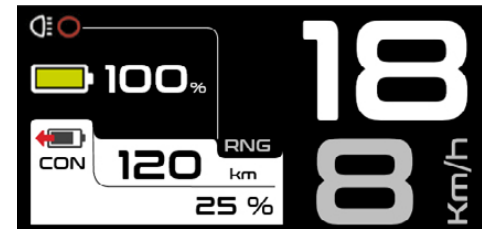

Battery consumption.



Nutrition reminder.



Hydration reminder.



Maintenance reminder.

ERROR CODES

Errors will be shown on the display. In some cases, the steps required to try and resolve the error will be included in the error notification message. The table below shows the possible errors and how they can be resolved.

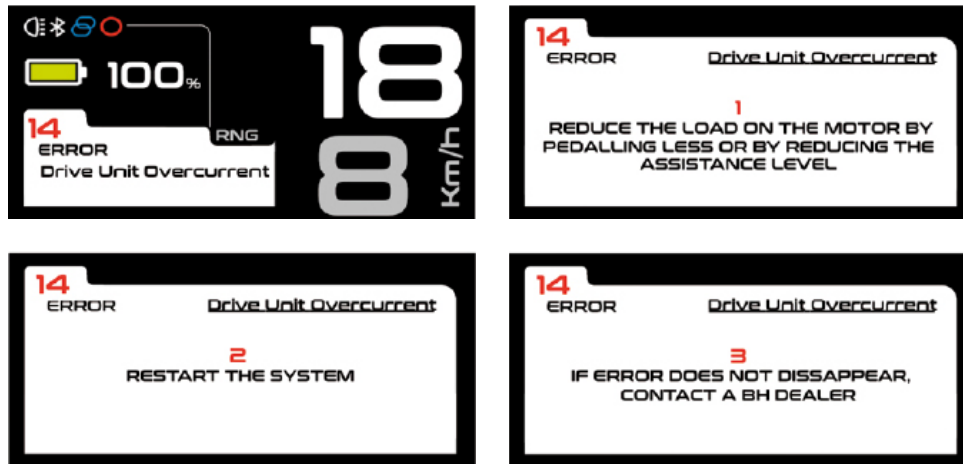

ERROR DESCRIPTIONS

Code	Description	Action required
1	Remote abnormal signal.	Restart the system.
2	Remote communication.	Make sure that the display connector 15 is plugged in correctly.
3	Torque sensor.	Restart the system.
4	Battery undervoltage.	Fully charge the battery with the original charger. restart the system.
5	Battery undervoltage.	Restart the system.
6	Motor Hall sensor.	Restart the system.
7	Motor overheating.	Stop riding and wait until the motor cools down.
8	Drive unit sensor overtemperature.	Restart the system.
9	Drive unit current out of range.	Restart the system.
11	Communication.	Make sure that the display connector is plugged in correctly. restart the system.

ERROR DESCRIPTIONS

Code	Description	Action required
12	Battery discharged.	Fully charge the battery with the original charger. Restart the system.
14	Drive unit overcurrent.	Reduce the load on the motor by pedalling less or by reducing the assistance level. Restart the system.
24	Drive unit power.	Restart the system.
25	Drive unit serial number not detected.	Restart the system.
26	Drive unit reset cause.	Restart the system.
33	Speed sensor.	Check speed sensor and magnet position in the wheel.
34	Drive unit overvoltage.	Restart the system.
35	Cadence sensor.	Restart the system.
36	Lights low voltage.	Check light cables and potential short.
193	Cell over voltage.	Fully discharge the battery. Fully charge the battery with the original charger. Once fully charged, keep the charger plugged in for 2 hours to balance the cells. Restart the system.
194	Cell undervoltage.	Fully discharge the battery. Fully charge the battery with the original charger. Once fully charged, keep the charger plugged in for 2 hours to balance the cells. Restart the system.
197	Overcurrent charge.	Check the status of the original charger. Restart the system.
198	Overcurrent discharge.	Restart the system.
199	Short circuit.	Check charger cable status. Restart the system.
204	Temperature charging.	Stop charging for 30 minutes. Restart the system.
205	Temperature discharging.	Restart the system.

07 SIZES AND DIMENSIONS

CARGO

		size	ST	TT	HT	BB	CS	WB	HTa	STa	Stack	Reach
V8 ROVER PRO	MC825	MD	480	625	200	45	660	1333	70	72	675	405
V8	MC815	MD	480	625	200	45	660	1333	70	72	675	405
V6 ROVER ST	MC645	MD	460	617	200	45	512	1193	69	72	663	401
V6 ROVER	MC625	MD	460	617	200	45	512	1193	69	72	663	401
V6 STRADA ST	MC635	MD	460	617	200	45	512	1193	69	72	663	401
V6 STRADA	MC615	MD	460	617	200	45	512	1193	69	72	663	401
V4	MC425	MD	405	607	185	40	650	1349	71	74	651	432

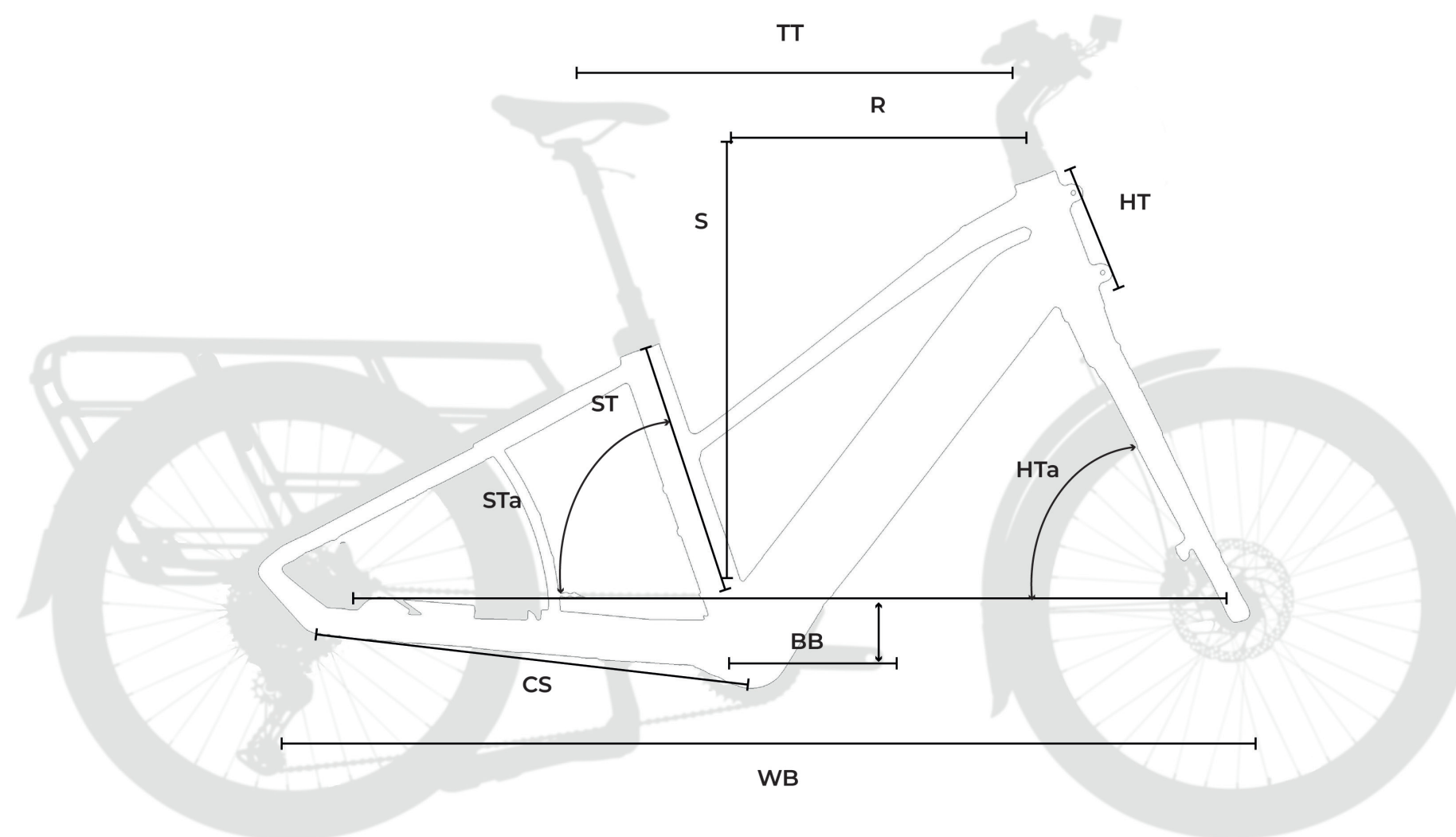

08 TECHNICAL SPECIFICATIONS

GENERAL SPECIFICATIONS

Characteristics	Models	Specification
Frame materials	All	Aluminium
Recommended use	All	Cargo / Utility / Hybrid / Urban
Sizes	All	MD
Suspension design	MC825 / MC645 / MC625 / MC425	Front suspension
	MC815 / MC635 / MC615	No
Fork travel	MC825 / MC425	80 mm
	MC645 / MC625	75 mm
Fork offset	All	Contact the model's supplier
Steering	All	1.5"-1.8" Steerer
Chain line	All	52mm
Compatible wheel size	MC825 / MC815 / MC645 / MC625 / MC635 / MC615	26"
	MC425	24"/20"
Maximum size of the rear tyre	All	2.6" (60mm)
Standard rear axle	MC825 / MC815 / MC645 / MC625 / MC425	Boost M12X148mm
	MC635 / MC615	135mm
Rear axle pitch thread	MC825 / MC815 / MC645 / MC625 / MC425	1.5mm
Length of the rear axle	MC825 / MC815 / MC645 / MC625 / MC425	172mm

Characteristics	Models	Specification
Seat post	All	Dropper hidraulic (manual)
Seat post diameter	All	31.6mm
Seat post clamp	All	Allen Key
Maximum insertion length of the seat post	All	240mm
Compatible with a telescopic seat post with internal cabling	All	No
Front derailleur	All	No. Only 1X
Chain ring size	MC825 / MC815 / MC645 / MC625 / MC635 / MC615	38t
	MC425	48t
Type of brakes	All	Disc brakes
Standard rear brake calliper	All	Post Mount
Maximum rear disc size	All	180mm
Minimum rear disc size	All	160mm
Front brake	MC825 / MC815 / MC645 / MC625 / MC425	203mm
	MC635 / MC615	180mm
Rear brake	MC825 / MC815 / MC645 / MC625 / MC425	180mm
	MC635 / MC615	160mm
Compatible with chain guides	All	Included
Cabling	All	Internal throught DT and CS. Full housing
Bottle holder	MC825 / MC815 / MC645 / MC625 / MC635 / MC615	Yes, standard bottle holder
	MC425	No

Characteristics	Models	Specification
Compatible with mudguard	All	Yes
Compatible with pannier rack	All	Yes
Compatible with child seat	All	Yes, for a maximum of 2 passengers
Compatible with trailer	All	Yes
Maximum recommended weight (bike+people+equipment+bags)	All	240 kg
Maximum recommended weight (front mik rack)	All	15 kg
Maximum recommended weight (back cargo rack)	All	70 kg

BH 1E-36V MOTOR SPECIFICATIONS

Characteristics	Specification
Rated power	250W
Voltage	36V
Type	Brushless DC
Assistance	Up to 25 km/h
Maximum torque	80Nm
Weight	3490g
Pedal assistance modes	5
Walk assist	Yes (by pressing and holding the + button)
Cadence range	130/min.
Sensors	Cadence / Torque / Speed
System technology	CAN bus

SPECIFICATIONS OF XDISPLAY LITE

Characteristics	Specification
Functions	Display of the charge level
	Display of errors

BATTERY SPECIFICATIONS

Characteristics	Specification
Voltage	36V
Capacity	540WH
Weight	3300g
Cell pack	30 (10S3P)
Charge level	With the battery mounted on the frame or outside the frame
Dimensions	395x87x87mm
Connection	Cable connected to the motor and charging port
Watertightness	IP65

CHARGER SPECIFICATIONS

Characteristics	Specification
Input	100-240V. 50-60Hz. AC
Output	42V
Charging current	3A
Charging temperature range	0°C - 40°C
Display of the charging progress	With the LED built into the charger

SPEED SENSOR SPECIFICATIONS

Characteristics	Specification
Assembly	On the left chainstay. Internal cabling
Magnet	On the rear wheel spokes

09 ASSEMBLY AND SPARE PARTS

DIMENSIONS OF THE STEERING TUBE

ALL MODELS

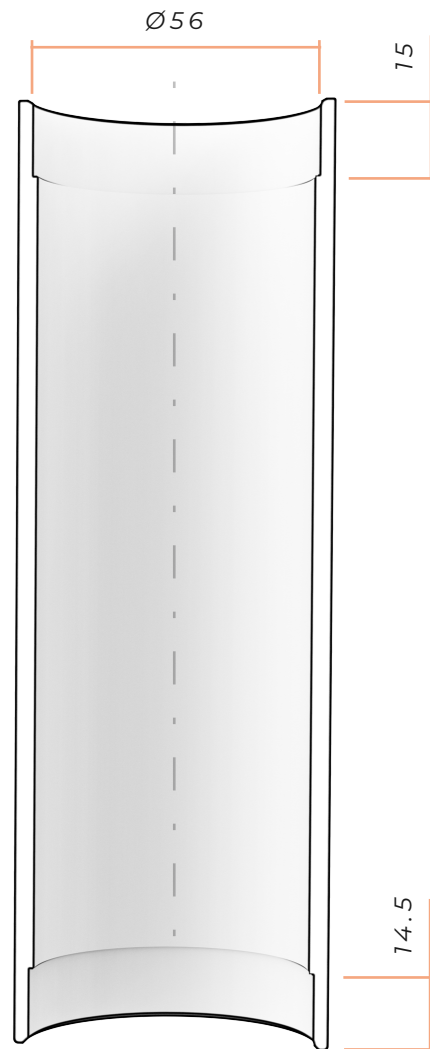

STEERING SPECIFICATIONS

Type		Contact angle with the compression ring / fork track
Upper	1.5" Steerer	0°
Lower	1.5" Steerer	0°

MOTOR BH 1E-36V

ALL MODELS

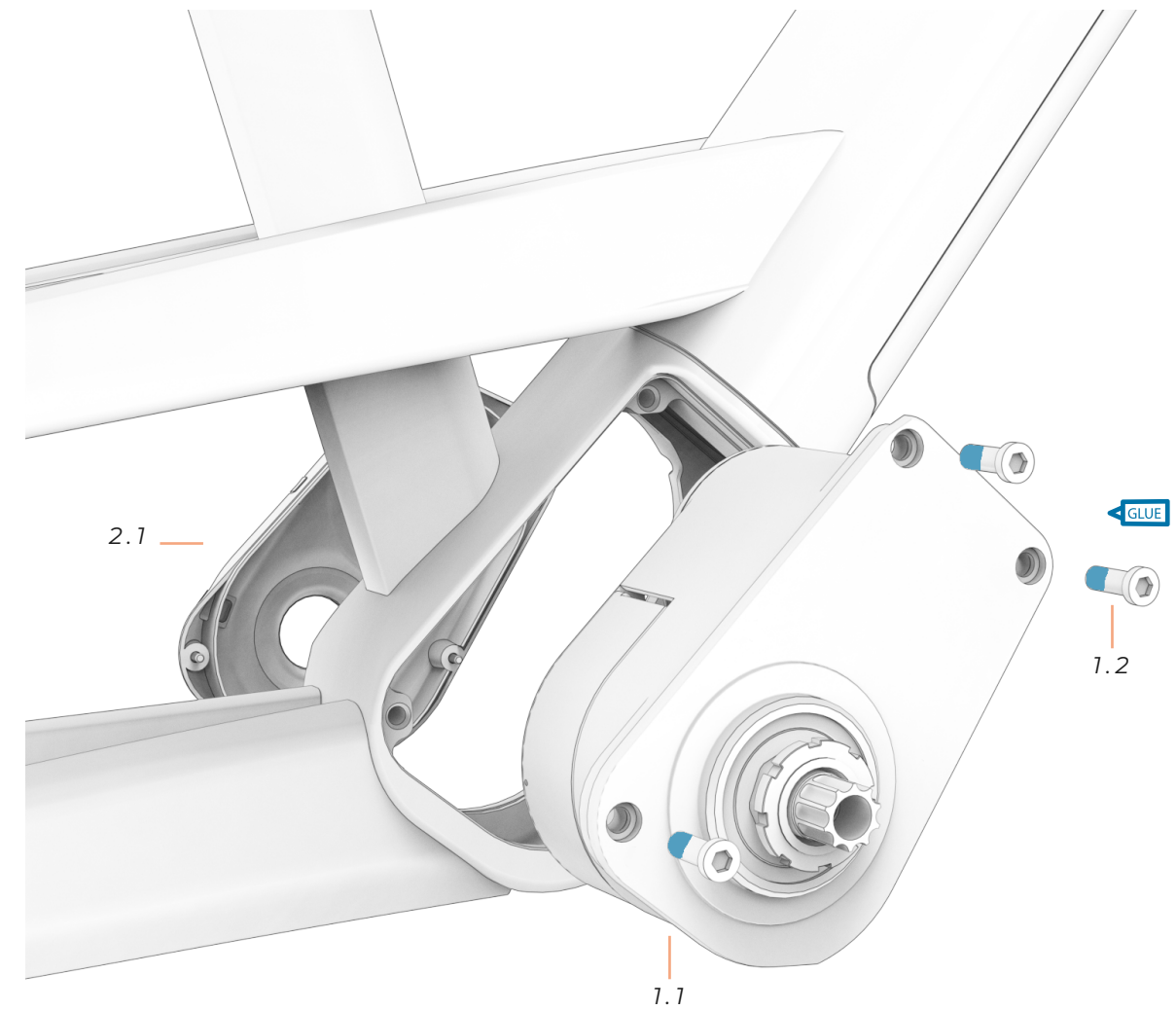

1 MOTOR

ref.: 387435400

No.	Item	Quantity
1.1	Motor	1
1.2	Screw	3

2 MOTOR COVER

ref.:

No.	Item	Quantity
2.1	Left motor cover	1

BATTERY

ALL MODELS



3 BATTERY ref.: 384680800

No.	Item	Quantity
3.1	Battery	1

4 BATTERY MOTOR CABLE ref.: 384680900

No.	Item	Quantity
4.1	Battery cable	1

5 BATTERY BASE ref.: 384681000

No.	Item	Quantity
5.1	Battery base cover	1
5.2	Screw	2

6 CHARGING PORT ref.:

No.	Item	Quantity
6.1	Charging port	1
6.2	Cover	1

! **ATTENTION:** To be installed in the upper and lower sides of the battery hollow space.

DISPLAY

ALL MODELS

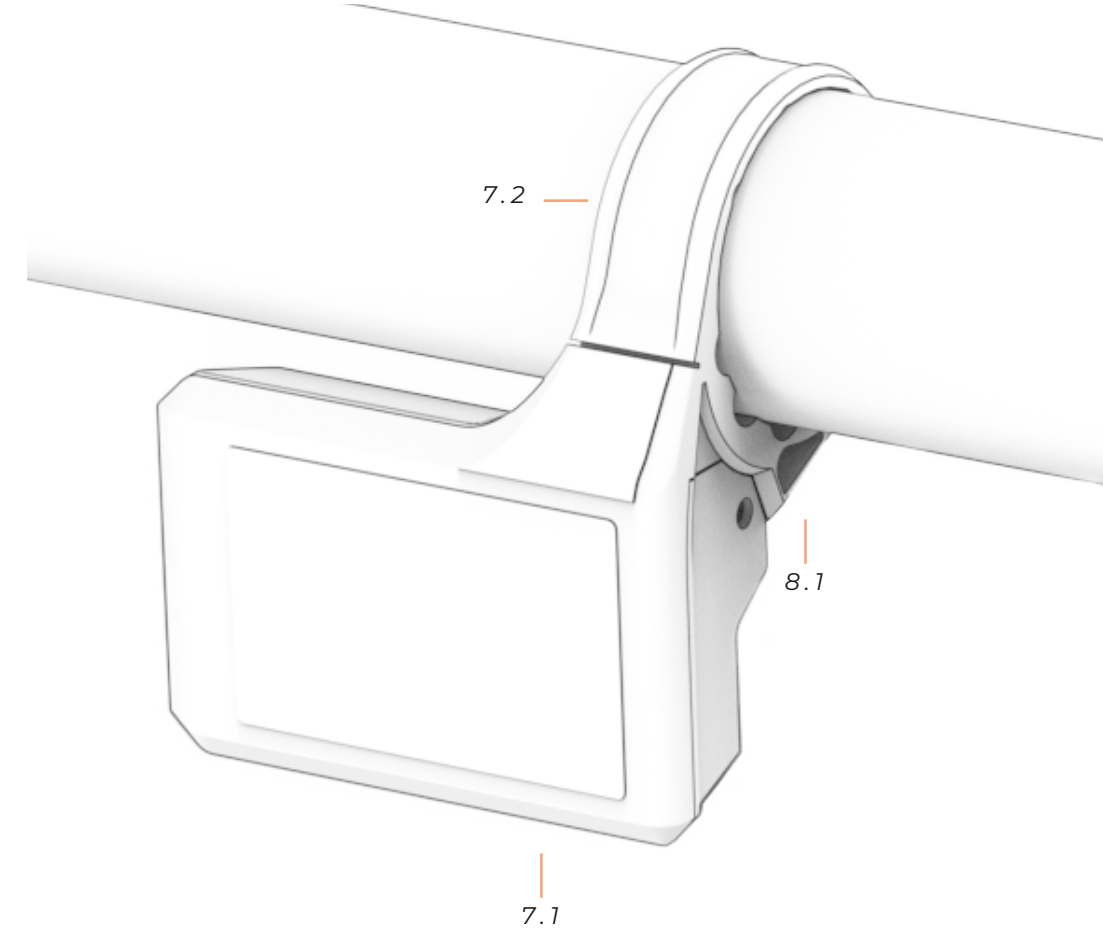

7 DISPLAY ref.: 386142800

No.	Item	Quantity
7.1	Display	1
7.2	Clamp	1

8 DISPLAY MOTOR CABLE ref.: 386142700

No.	Item	Quantity
8.1	Display cable	1

SADDLE SEAT POST

ALL MODELS

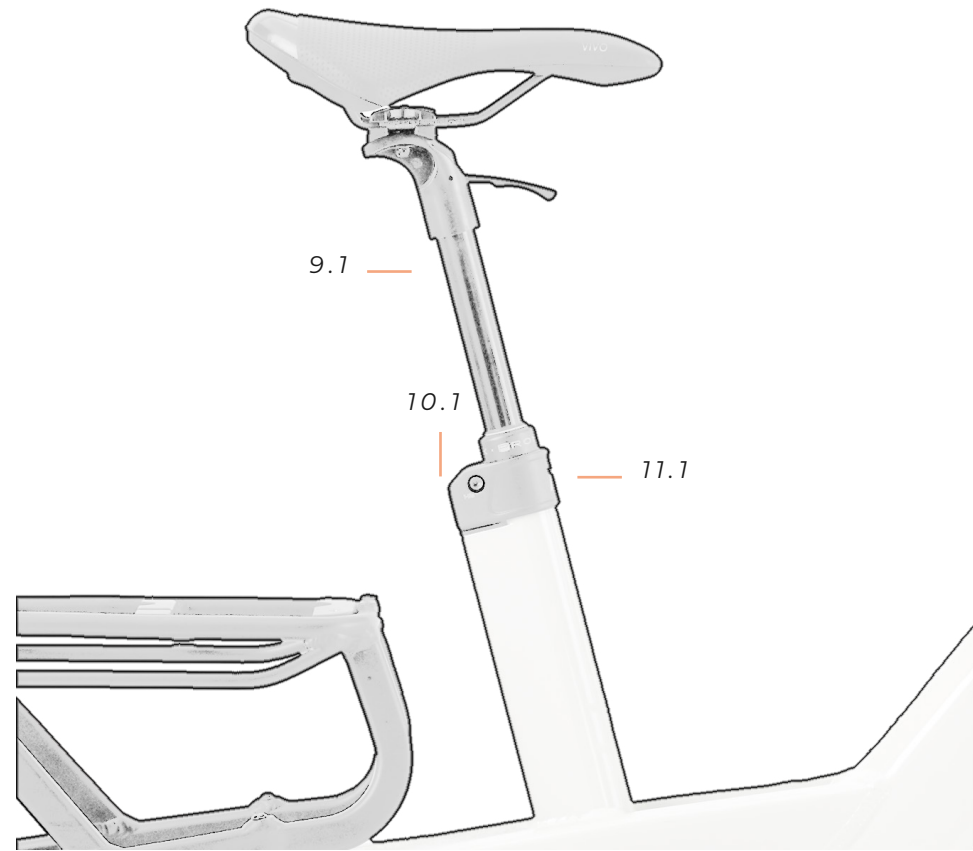

9 SEAT POST

ref.: 361334100

No.	Item	Quantity
9.1	Seat Post	1

10 TUBE PROTECTOR

ref.: 365366000

No.	Item	Quantity
10.1	Protector	1

11 SEAT POST CLAMP

ref.: 381555100

No.	Item	Quantity
11.1	Clamp	1
11.2	Screw	1

SPEED SENSOR

ALL MODELS

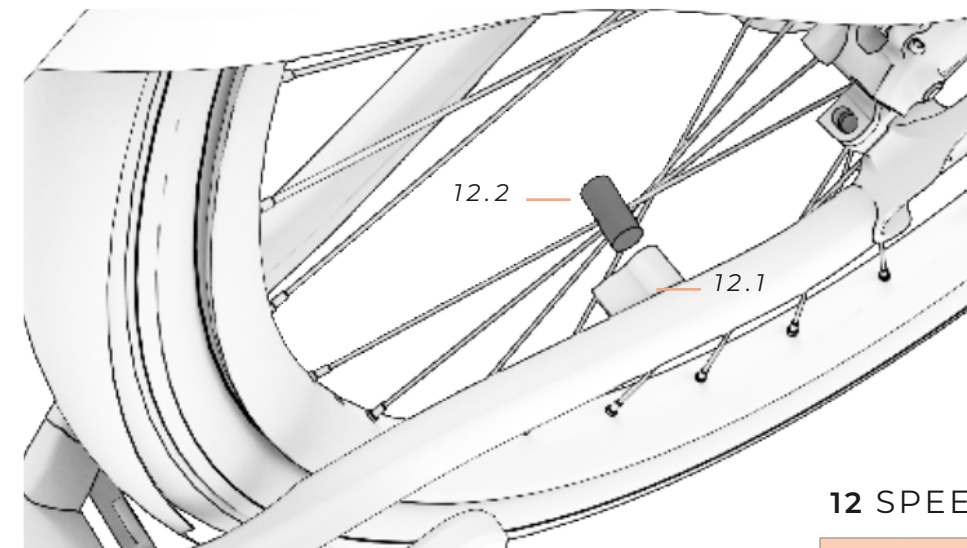

12 SPEED SENSOR

ref.:

No.	Item	Quantity
12.1	Speed sensor	1
12.2	Magnet	1

HANGER

ALL MODELS



13 HANGER

ref.: 391840200

No.	Item	Quantity
13.1	Hanger	1
13.2	Bolt	1

ACCESSORIES

ALL MODELS

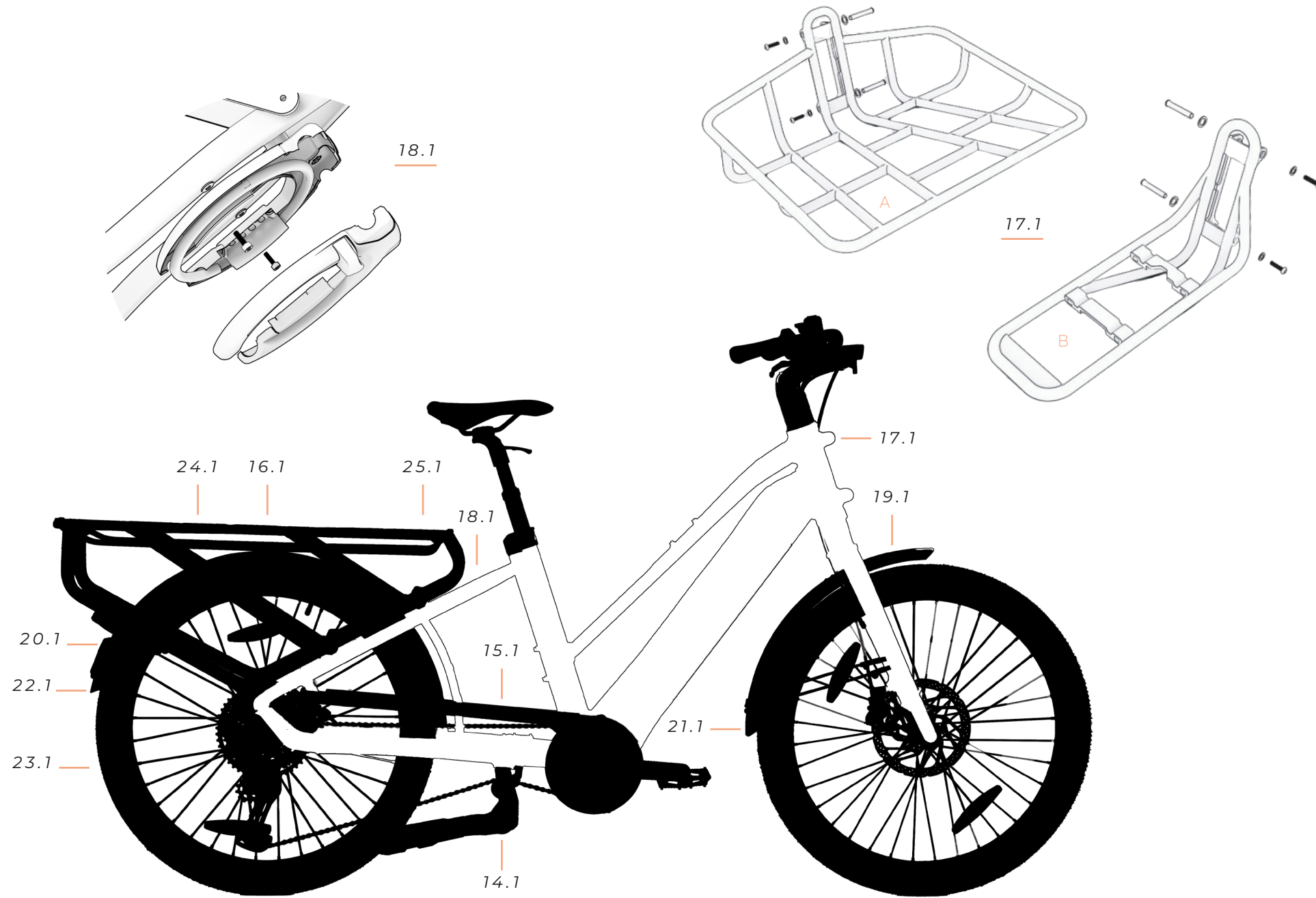

14 CHAIN GUIDE ref.: 342300800

No.	Item	Quantity
14.1	Chain guide	1

15 CHAIN GUARD ref.: 352179300

No.	Item	Quantity
15.1	Chain guard	1

16 PANNIER ref.: 342300300

No.	Item	Quantity
16.1	Pannier	1

17 FRONT PANNIER ref.: 381555400/381555300

No.	Item	Quantity
17.1	Front pannier	1

18 REAR PADLOCK ref.: Axa spare part

No.	Item	Quantity
18.1	Padlock	1

19 HEADLIGHT ref.: 387463200

No.	Item	Quantity
19.1	Headlight	1

20 REAR LIGHT ref.: 387463000

No.	Item	Quantity
20.1	Rear light	1

ACCESSORIES

ALL MODELS

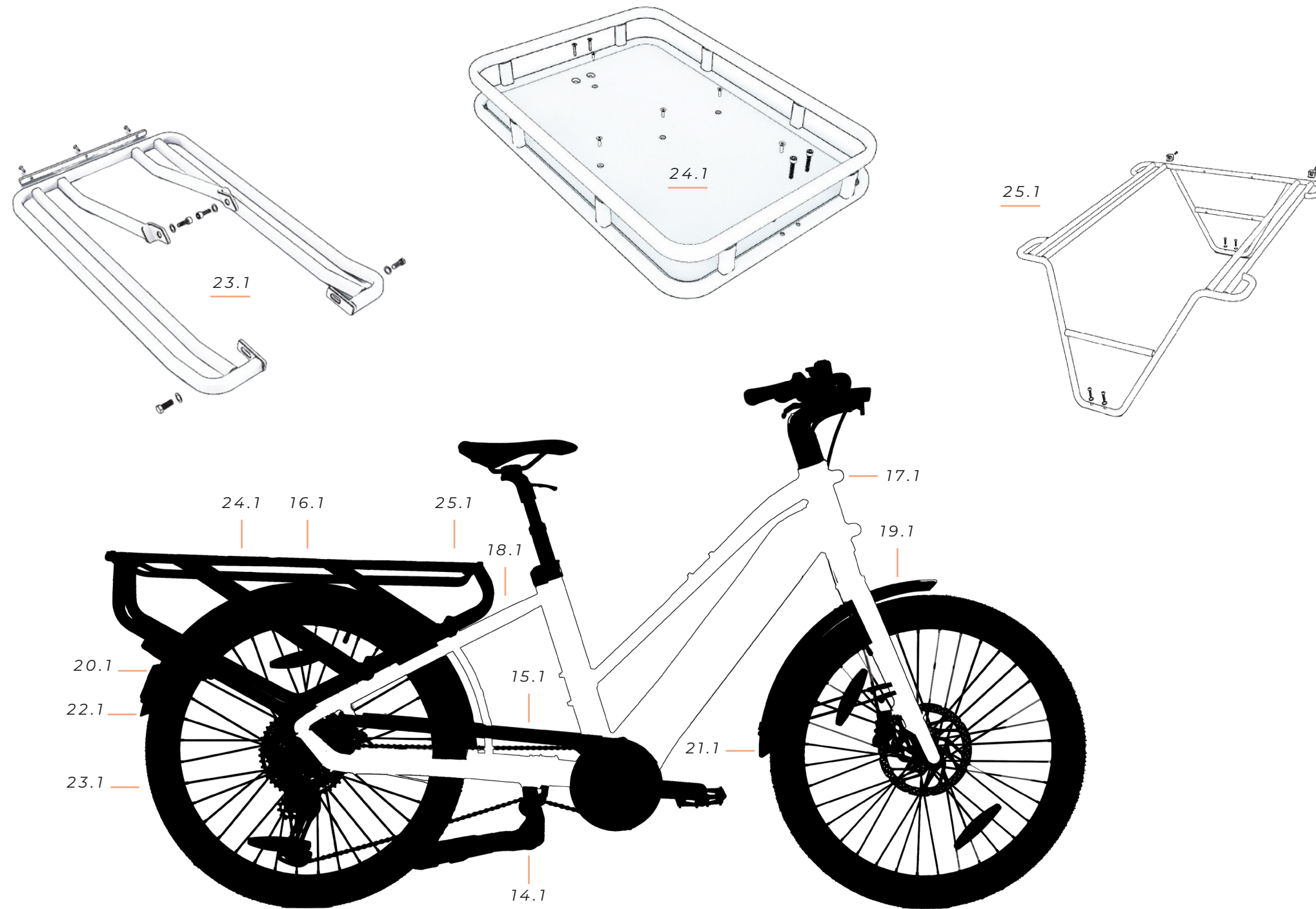

21 FRONT FENDER ref.: 342300000

No.	Item	Quantity
21.1	Front fender	1

22 REAR FENDER ref.: 342300100

No.	Item	Quantity
22.1	Rear fender	1

23 BASE ref.: ^{V4}381555700/^{V6}381555800/^{V8}381555900

No.	Item	Quantity
23.1	Base	1

24 CARGO RACK ref.: 381555500

No.	Item	Quantity
24.1	Cargo rack	1

25 UTILITY BARS ref.: 381555600

No.	Item	Quantity
25.1	Utility bars	1

ATTENTION: 24.1 Cargo Rack and 25.1 Utility Bars are assembled above the 16.1 Pannier.

CABLING OF THE MECHANICAL PARTS

The images below show the routing configuration for the mechanical component cables. The cables will remain protected inside the frame triangle until they come out through the motor cover for ease of maintenance.

ALL MODELS

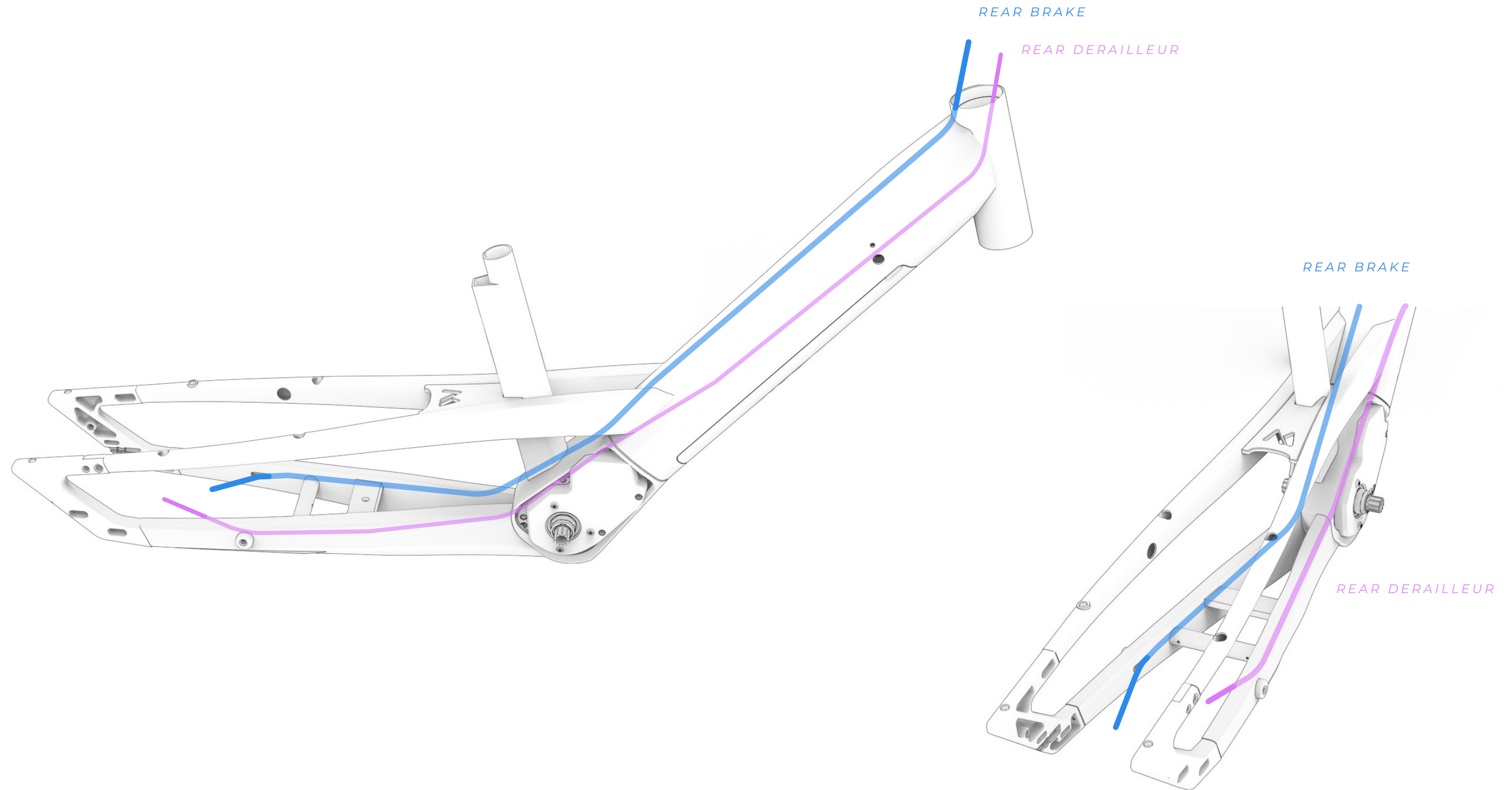

CABLING OF THE ELECTRICAL SYSTEM'S PARTS

The images below show the routing configuration for the electrical component cables.

ALL MODELS

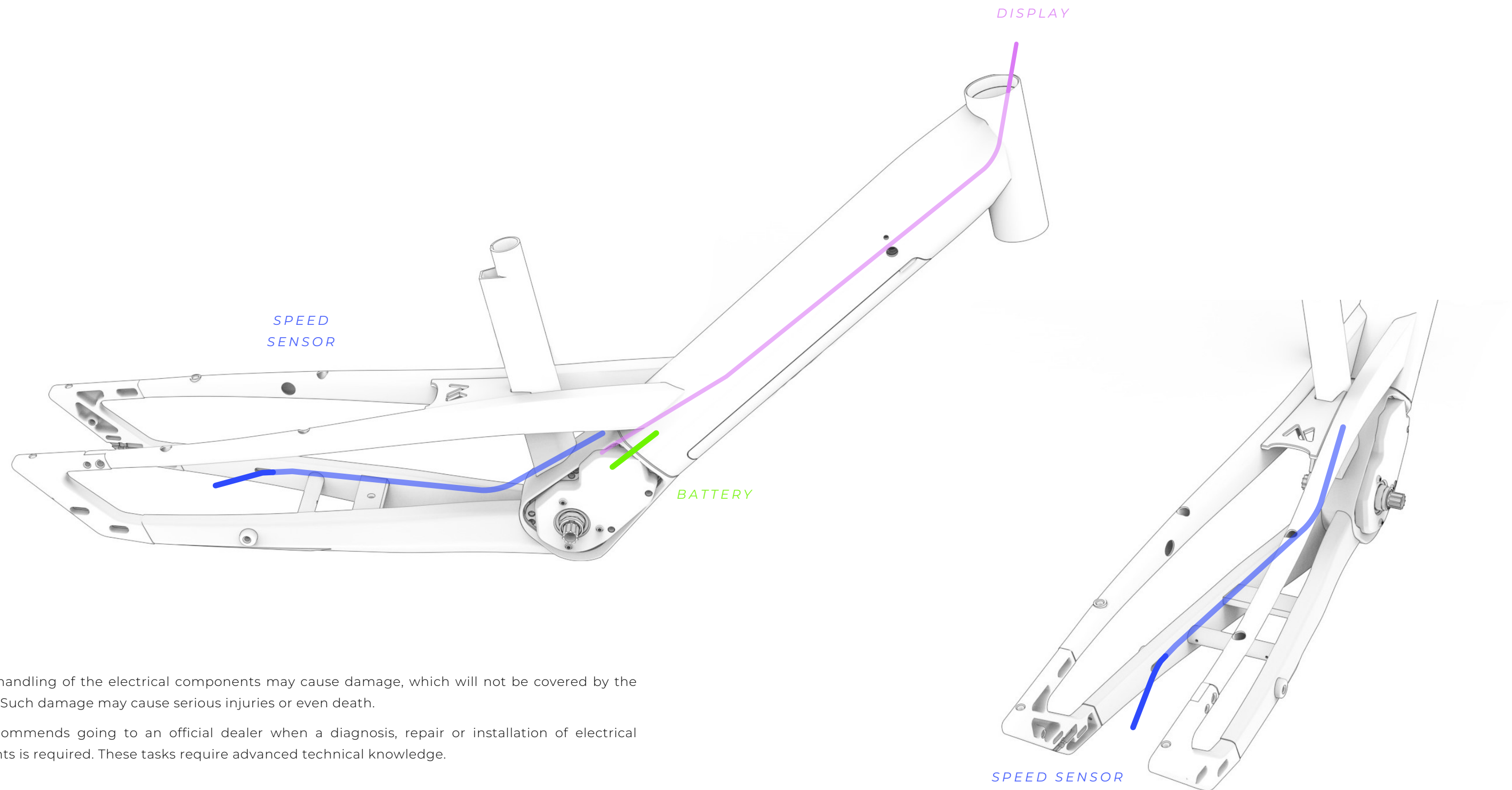

⚠ Incorrect handling of the electrical components may cause damage, which will not be covered by the warranty. Such damage may cause serious injuries or even death.

Monty recommends going to an official dealer when a diagnosis, repair or installation of electrical components is required. These tasks require advanced technical knowledge.

WIRING DIAGRAM OF THE ELECTRICAL SYSTEM'S PARTS

ALL MODELS

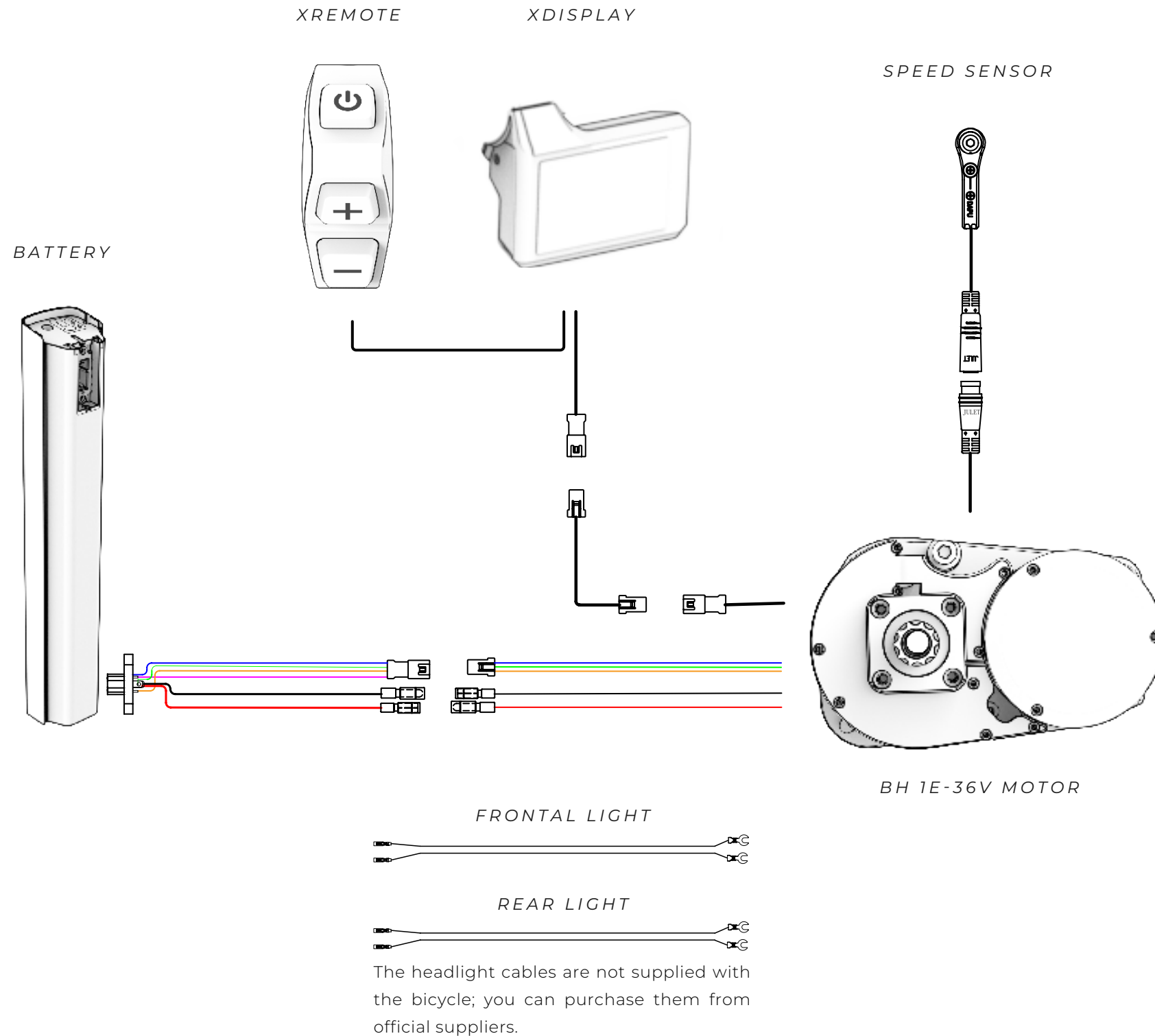

⚠ Incorrect handling of the electrical components may cause damage, which will not be covered by the warranty. Such damage may cause serious injuries or even death.

Monty recommends going to an official dealer when a diagnosis, repair or installation of electrical components is required. These tasks require advanced technical knowledge.

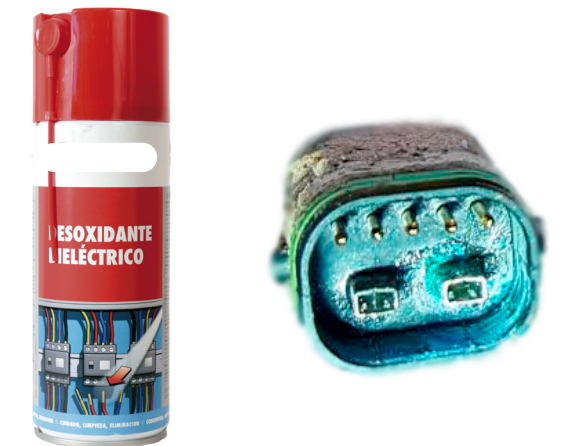

⚠ When electrical connections come into contact with damp spots or are clogged due to external contamination, a chemical reaction occurs, causing a build-up of lead sulphate crystals in the connections. In other words, the copper on the contacts will rust, resulting in conductivity problems.

The warranty does not cover damage caused by incorrect maintenance of the bicycle's connections. To prevent rust, simply clean the connections (male and female) at regular intervals, using dielectric deoxidisers like the one shown in the image above.

10 DECLARATION OF CONFORMITY

EU Declaration of Conformity

The manufacturer: BH BIKES EUROPE, SL
c/ Perretagana 10,
01015 Vitoria, Spain

Hereby declares that the following products:

Product description:  Cargo E-Bikes.

Models designation:

CARGO E-BIKES:
V4, V4 ROVER, V6, V6 STRADA, V6 ROVER, V8, V8 ROVER, W12 TRACKER, W12 TRACKER PLUS

Year of manufacture: 2022 and 2023

Comply with all of the relevant requirements of the Machinery Directive (2006/42/EC).
Comply with Low Voltage Directive (LVD) 2014/35/EU
Comply with all of the relevant requirements of RD 339/2014, de 9 de Mayo.
Furthermore, the machine complies with all of the requirements of the Electromagnetic Compatibility Directive 2014/30/EU.

The production control is assured by our Quality Management System, which fulfills the requirements of the standard ISO 9001

The following harmonized standards have been applied:
DIN EN 15194 Cycles – Electrically power assisted cycles – EPAC bicycles;
DIN ISO 4210-1/2/3/4/5/6/7/8/9 Safety requirements for bicycles
NF R 30-050-1 Exigences communes aux cycles avec ou sans assistance électrique

Technical documentation filed at:
BH BIKES EUROPE, SL
c/ Perretagana 10,
01015 Vitoria, Spain



José María Chapinal
Quality Manager
BH BIKES EUROPE, SL

11 HELP AND ADDITIONAL RESOURCES

Monty offers different channels to resolve your queries. In addition, you can join our global cyclist community on our social media.

TECHNICAL RESOURCES

You can find all of the resources you need to fine-tune your bicycle on the Monty Bikes website. Click on the link below to access the user manuals, apps, warranties, display update files and videos that explain different operations:

<https://www.montybikes.com/manuales/> or <https://www.bhbikes.com/manuales/>

You can also check out our step-by-step tutorials to learn how to maintain and fine-tune your bicycle on our specialised Youtube channel:

<https://www.youtube.com/user/ServicioTecnicoBH>

CONTACT US

Our authorised dealers have the necessary knowledge and resources to help you with anything you need in relation to your bicycle. Don't hesitate to contact your nearest store. You can find it by clicking on the link below:

<https://www.montybikes.com/store-locator/>

To contact us directly:

Tel.: + 34 945 13 52 02

info@montybikes.com

P.I. Jundiz- Perretagana 10, 01015 Vitoria, Alava (Spain)

SOCIAL MEDIA

Join our global cyclist community. Discover the Monty experiences of other cyclists and share yours.





www.montybikes.com



MONTY
BIKES